

# ARKADIUS

Armchair, Sofa, System

Norm Architects,  
2026

laCividina



**DATI TECNICI  
TECHNICAL DATA  
DONNÉES TECHNIQUES  
TECHNISCHE ANGABEN**

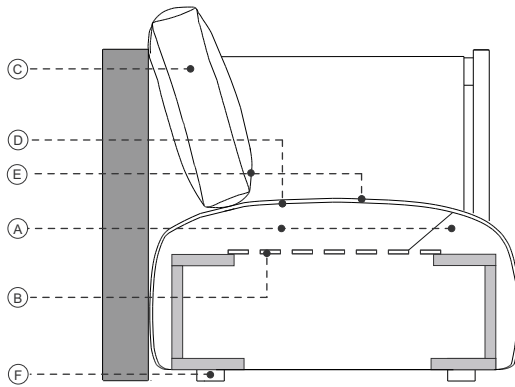

- |  |   |  |  |
|--|---|--|--|
| ■ Frassino<br>■ Legno massiccio di faggio                                  | ■ Ash<br>■ Solid beech  | ■ Frêne<br>■ Bois de hêtre massif  | ■ Eschenholz<br>■ Massivholz aus Buche   |
| <b>A.</b> Poliuretano espanso ignifugo indeformabile a quote differenziate | <b>A.</b> Flame-retardant undeformable polyurethane foam of different densities | <b>A.</b> Mousse polyuréthane expansé ignifuge indéformable à épaisseurs différenciées | <b>A.</b> Feuerfester formbeständige Polyurethanschaum in unterschiedlicher Dichte |
| <b>B.</b> Cinghie elastiche ad alta densità                                | <b>B.</b> High density elastic straps   | <b>B.</b> Sangles élastiques   | <b>B.</b> Elastischen Gurtbändern  |
| <b>C.</b> 100 % poliestere   | <b>C.</b> 100% Polyester  | <b>C.</b> 100 % polyester  | <b>C.</b> 100 % Polyester  |
| <b>D.</b> Fibra di poliestere  | <b>D.</b> Polyester fibers  | <b>D.</b> Fibre de polyester   | <b>D.</b> Polyester  |
| <b>E.</b> Rivestimento fisso in tessuto o pelle                            | <b>E.</b> Fixed upholstery in fabric or leather                                 | <b>G.</b> Revêtement pas déhoussable en tissu ou cuir                                  | <b>E.</b> Unabziehbarer Bezug aus Stoff oder Leder                                 |
| <b>F.</b> Polipropilene nero   | <b>F.</b> Black polypropylene   | <b>F.</b> Polypropylène noir   | <b>F.</b> Schwarz Polypropylen   |

**NOTE  
NOTES  
ANNOTATION  
ANMERKUNG**

- |  |  |   |   |
|--|--|---|---|
| <ul style="list-style-type: none"> <li>• Prodotto disponibile su misura con preventivo su richiesta</li> <li>• COM: tessuto cliente (tinta unita e h.140 cm.) - campione richiesto</li> <li>• COL: pelle cliente - campione richiesto</li> </ul> | <ul style="list-style-type: none"> <li>• This item can be tailor made with price on request</li> <li>• COM: client's fabric (plain colour and width 140 cm.) - sample required</li> <li>• COL: client's leather - sample required</li> </ul> | <ul style="list-style-type: none"> <li>• Collection personnalisable sur demande</li> <li>• COM: tissu fourni (couleur unie et hauteur 140 cm.) - échantillon nécessaire</li> <li>• COL: cuir fourni - échantillon nécessaire</li> </ul> | <ul style="list-style-type: none"> <li>• Produkt nach Maß verfügbar auf Anfrage</li> <li>• COM: Kundenstoff (einfarbig und Breite 140 cm.) - Stoffmuster nötig</li> <li>• COL: Kundenleder - Ledermuster nötig</li> </ul> |
|--|--|---|---|

**FINITURA BASE LACCATA LUCIDA  
HIGH- GLOSS LACQUERED BASE FINISH  
FINITION PIÈMENT LAQUÉ  
GLÄNZENDLACKIERTE BASIS  
AUSFÜHRUNG**



Frassino naturale  
Natural ash  
Frêne naturel  
Eschenholz Naturfarbe



Frassino tinto grafite  
Graphite-stained ash  
Frêne teinté graphite  
Eschenholz Graphit gebeizt

**SISTEMA DI AGGANCIAMENTO  
SYSTEM CONNECTOR  
SYSTEME D'ASSEMBLAGE  
VERBINDUNGSHAKEN**



Sistema di aggancio tra elementi  
Components connector  
Systeme d'assemblage de socle  
Verbindungssystem zwischen Elementen

**RIVESTIMENTI CONSIGLIATI  
RECOMMENDED COVERINGS  
REVÊTEMENTS CONSEILLÉS  
EMPFOHLENE BEZÜGE**

**CAT. START**  
RINGO  
OPUS

**CAT. A**  
XTREME  
TAILOR  
ANGEL  
MEDLEY  
SAMAR  
AVON  
MAGNUM  
AUTUMN  
HANGO  
BIG  
MAMA

**CAT. B**  
FAME  
MAIN LINE FLAX  
HESTAN  
SILVERTEX

**CAT. C**  
SUPERB  
TREND  
KEN BI  
MIKONOS  
ANDROS  
ACAPULCO  
MINORCA  
LAMPEDUSA

**CAT. SUPER**  
ORSETTO  
REMIX 3  
MYLLA  
TWISTED FLOWER  
DHARMA DIS.400  
DHARMA DIS.200  
DHARMA DIS.600  
DHARMA DIS.100  
DHARMA DIS.500  
DIVA DIS.01

**CAT. EXTRA**  
STEELCUT TRIO 3  
ARIANA  
OPERA  
ARCO  
CREDO  
TRIO  
BIT  
DIVA DIS.05  
DIVA DIS.21  
DIVA DIS.29

**CAT.MAXI**  
UNIFORM MÉLANGE  
HALLINGDAL 65  
DIVINA 3

**CAT. TOP**  
ARDA  
REGOS

**CAT. SPECIAL**  
GENTLE 2

**CAT. LUX**  
LUX 1  
LUX 2

**CAT. IMPERIAL**  
IMPERIAL 1  
IMPERIAL 2

**POLTRONA  
ARMCHAIR  
FAUTEUIL  
SESSEL**

**COD.1800  
ARMCHAIR**

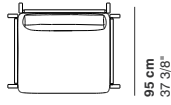
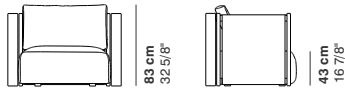

111 cm  
43 3/4"

**DIVANI  
SOFAS  
CANAPÉS  
SOFAS**

**COD.1801  
SOFA 2 SEATER**

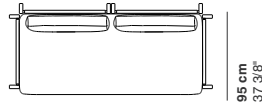
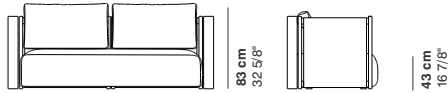

203 cm  
79 7/8"

**COMPONIBILI  
SYSTEM  
CANAPÉS MODULAIRES  
MODULAR SOFAS**

**COD.1802  
ELEMENT 91**

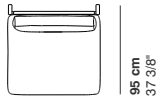
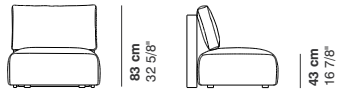

91 cm  
35 7/8"

**COD.1803SX  
ELEMENT 91 LEFT**

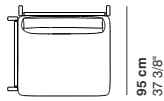
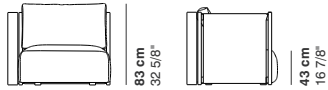

101 cm  
39 3/4"

**COD.1804DX  
ELEMENT 91 RIGHT**

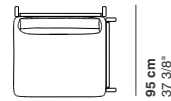
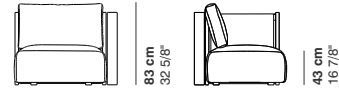

101 cm  
39 3/4"

**COD.1805  
ELEMENT 182**

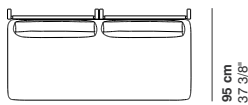
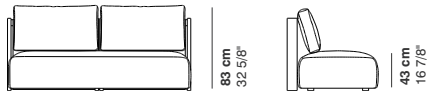

182 cm  
71 5/8"

**POLTRONA  
ARMCHAIR  
FAUTEUIL  
SESSEL**

**COD.1806SX  
ELEMENT 182 LEFT**

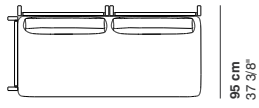
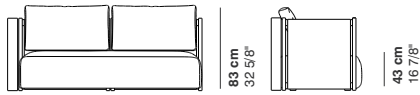

193 cm  
76

**COD.1807DX  
ELEMENT 182 RIGHT**

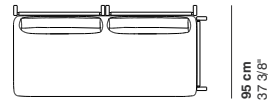
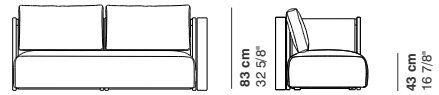

193 cm  
76

**DORMEUSE  
DORMEUSE  
DORMEUSE  
DORMEUSE**

**COD.1808  
DORMEUSE**

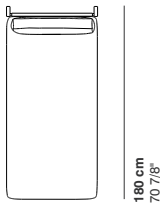
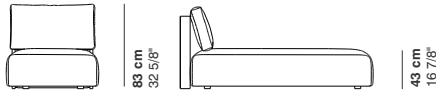

91 cm  
35 7/8"

**COD.1809SX  
DORMEUSE LEFT**

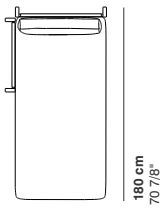
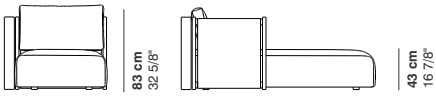

101 cm  
35 7/8"

**COD.1810DX  
DORMEUSE RIGHT**

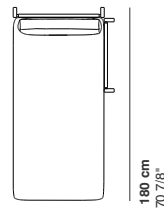

101 cm  
35 7/8"

**CORNER**

**COD.1811  
CORNER**

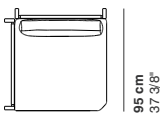
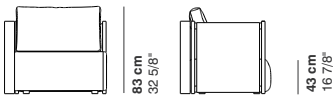

101 cm  
39 3/4"

**ELEMENTI ESAGONALE**  
**HEXAGONAL ELEMENTS**  
**ÉLÉMENT HEXAGONAL**  
**SECHSECKIGES ELEMENT**

**COD.1812**  
**ESAGONALE DOUBLE BACK**

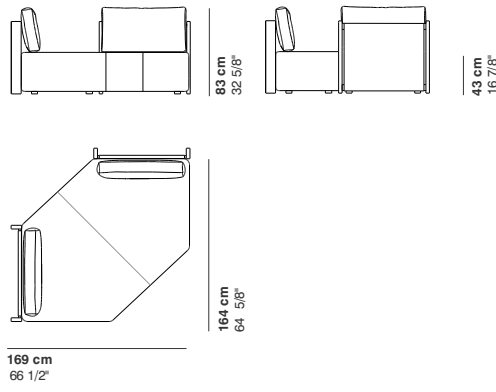

**COD.1813**  
**ESAGONALE TRIPLE BACK**

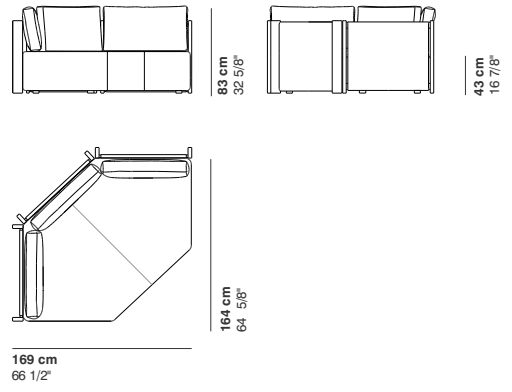

**POUFS**  
**OTTOMANS**  
**POUFS**  
**HOCKER**

**COD.1814**  
**POUF 91**

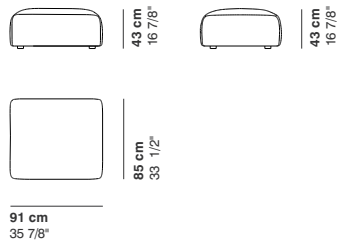

**COD.1815**  
**POUF 182**

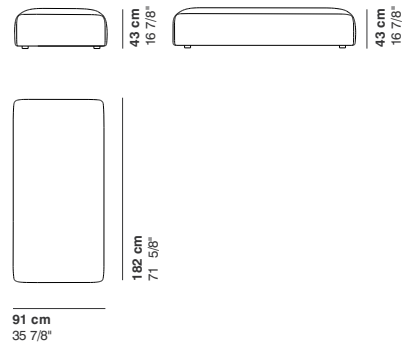

**COD.1816**  
**HEXAGONAL POUF**

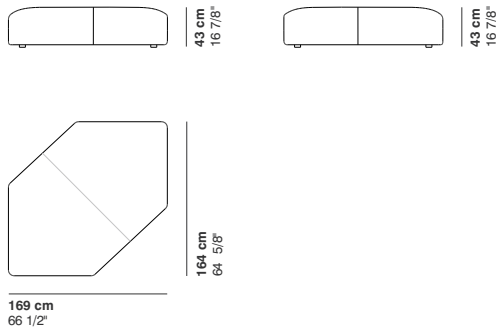

---

La Cividina s.r.l., al fine di migliorare le caratteristiche tecniche e qualitative della sua produzione, si riserva di apportare, anche senza preavviso, tutte le modifiche che si rendessero necessarie.

With a view to improving the technical characteristics and quality of its products la Cividina s.r.l. reserves the right to develop its products at anytime without notice.

A fin d'améliorer les caractéristiques de sa production, La Cividina s.r.l. se réserve d'apporter, même sans préavis, toutes les modifications qui se rendent nécessaires.

Zur Verbesserung, der technischen und qualitativen Merkmale, behält sich La Cividina s.r.l. vor, alle notwendigen Produktionsänderungen, auch ohne Vorankündigung durchzuführen.

---

**LA CIVIDINA S.R.L.**

**HEADQUARTERS / PRODUCTION**

Via Spilimbergo 162  
33035 Martignacco  
Udine Italy  
T +39 0432 677433  
F +39 0432 677480  
[info@lacividina.com](mailto:info@lacividina.com)  
[lacividina.com](http://lacividina.com)

**ISO 9001**



**SHOWROOM MARTIGNACCO**

Via Lungolavia 1  
33035 Martignacco  
Udine Italy  
T +39 0432 677433

**SHOWROOM MILANO**

Palazzo Borromeo d'Adda  
Via Manzoni 41  
20121 Milano  
Italy  
T +39 345 8350810