

APPER

Armchair, Sofa, System

Antonio Rodriguez,
2024

laCividina



**DATI TECNICI
TECHNICAL DATA
DONNÉES TECHNIQUES
TECHNISCHE ANGABEN**

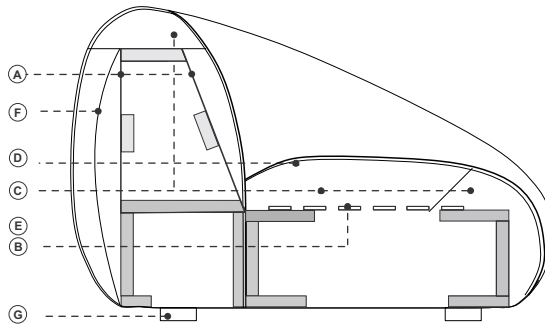

- Legno massiccio di abete
- Legno massiccio di faggio

- A.** Pannello di masonite
- B.** Cinghie elastiche ad alta densità
- C.** Poliuretano espanso ignifugo indeformabile a quote differenziate
- D.** Fibra di poliestere
- E.** Rivestimento in tessuto
- F.** Vetroresina
- G.** Polipropilene nero

- Solid fir
- Solid beech

- A.** Masonite panels
- B.** High density elastic straps
- C.** Flame-retardant undeformable polyurethane foam of different densities
- D.** Polyester fibers
- E.** Upholstery in fabric
- F.** Fiberglass
- G.** Black polypropylene

- Bois de sapin massif
- Bois de hêtre massif

- A.** Panneau de particules
- B.** Sangles élastiques
- C.** Mousse polyuréthane expansé ignifuge indéformable à épaisseurs différenciées
- D.** Fibre de polyester
- E.** Revêtement en tissu
- F.** Fibre de verre
- G.** Polypropylène noir

- Massiveholz aus Tanne
- Massiveholz aus Buche

- A.** Holzfaserplatte
- B.** Elastischen Gurtbändern
- C.** Feuerfester formbeständige Polyurethanschaum in unterschiedlicher Dichte
- D.** Polyesterfaser
- E.** Stoffüberzug
- F.** Fiberglass
- G.** Schwarz Polypropylen

**NOTE
NOTES
ANNOTATION
ANMERKUNG**

- Prodotto disponibile su misura con preventivo su richiesta
- Base personalizzabile con tinta cliente
- Su richiesta attacco per connessione elettrica e USB con sovrapprezzo
- Cuscini extra disponibili
- COM: tessuto cliente (tinta unita e h.140 cm.) - campione richiesto
- COL: pelle cliente - campione richiesto

- This item can be tailor made with price on request
- Base customizable with customer's colors on request
- Electrical connection and USB upon request with upcharge
- Extra cushions available
- COM: client's fabric (plain colour and width 140 cm.) - sample required
- COL: client's leather - sample required

- Collection personnalisable sur demande
- Piètement disponible en autres finitions sur demande
- Sur demande connection électrique et USB avec surcoût
- Autres coussins disponibles
- COM: tissu fourni (couleur unie et hauteur 140 cm.) - échantillon nécessaire
- COL: cuir fourni - échantillon nécessaire

- Produkt nach Maß verfügbar auf Anfrage
- Gestell in Kundenfarben auf Anfrage verfügbar
- Elektrische Verbindung und USB-Anschluss auf Anfrage gegen Aufpreis
- Weitere Kissen verfügbar
- COM: Kundenstoff (einfarbig und Breite 140 cm.) - Stoffmuster nötig
- COL: Kundenleder - Ledermusternötig

**OPZIONE
OPTION
OPTION
OPZION**



Su richiesta attacco per connessione elettrica e USB con sovrapprezzo
Electrical connection and USB upon request with upcharge
Sur demande connection électrique et USB avec surcoût
Elektrische Verbindung und USB-Anschluss auf Anfrage gegen Aufpreis

**RIVESTIMENTI CONSIGLIATI
RECOMMENDED COVERINGS
REVÊTEMENTS CONSEILLÉS
EMPFOHLENE BEZÜGE**

CAT. B
STRETCHY
MAIN LINE FLAX

CAT. EXTRA
BIT

CAT. MAXI
MOSAIC 2
UNIFORM MÉLANGE

CAT. SPECIAL
GENTLE 2
TRIANGLE

CAT. SUPER
MYLLA

CAT. TOP
ARDA

POLTRONA
ARMCHAIR
FAUTEUIL
SESSEL

COD.1460
ARMCHAIR

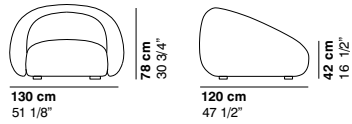

DIVANI
SOFAS
CANAPÉS
SOFAS

COD.1461
SOFA 3 SEATER

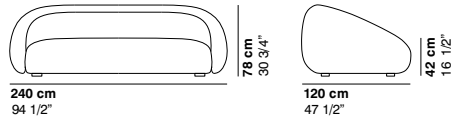

COMPONIBILI
SYSTEM
CANAPÉS MODULAIRES
MODULAR SOFAS

COD.1462
ELEMENT 150 SX

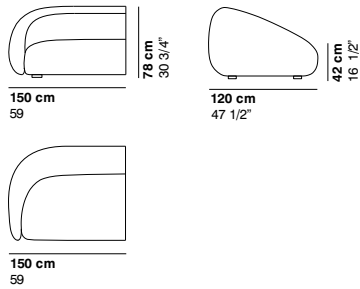

COD.1463
ELEMENT 150 DX

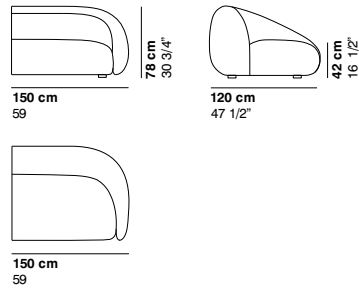

COD.1464
ELEMENT CURVED SX 150 r450

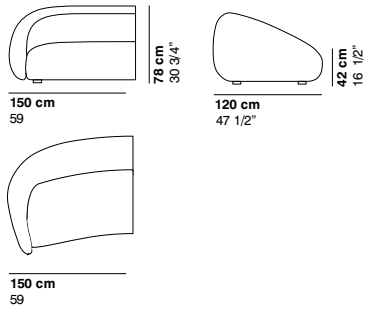

COD.1465
ELEMENT CURVED DX 150 r450

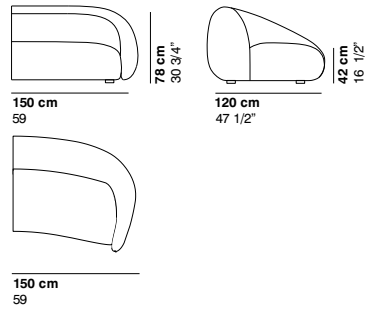

COD.1466
ELEMENT CURVED 148 r193

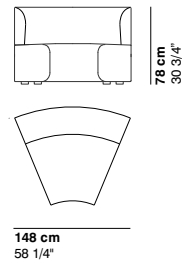

COD.1467
ELEMENT CURVED 150 r450

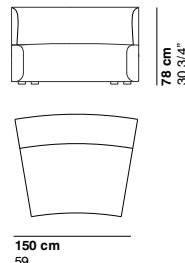

COD.1468
ELEMENT 100

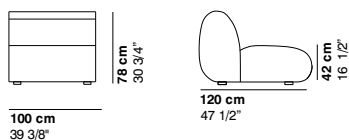

COD.1469
ELEMENT 150

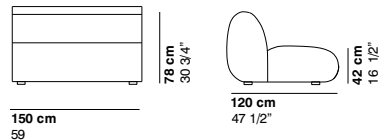

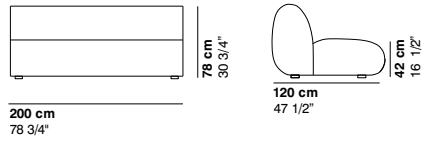

COD.1471
DORMEUSE SX

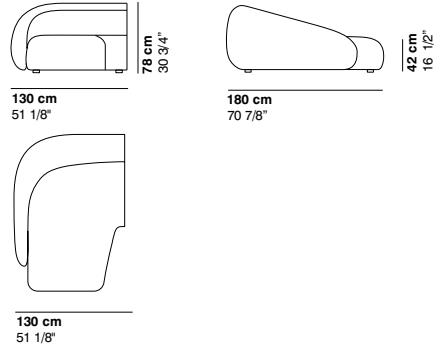

COD.1472
DORMEUSE DX

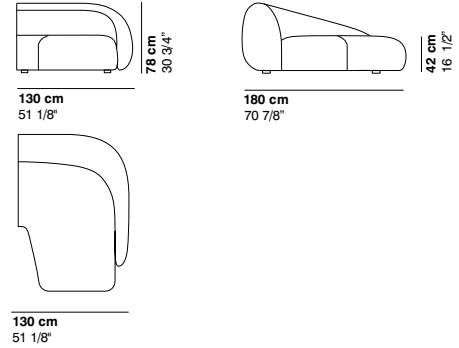

COMPOSIZIONI
COMPOSITIONS
COMPOSITIONS
KOMPOSITIONEN

APP01

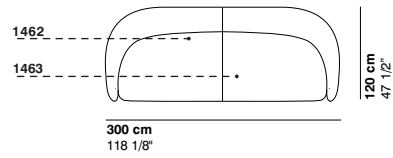

APP02

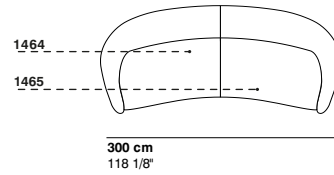

APP03

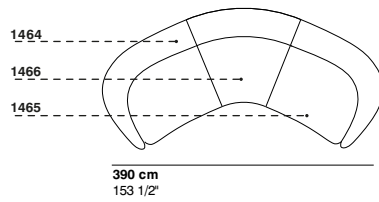

APP04

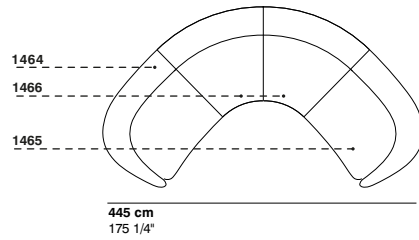

APP05

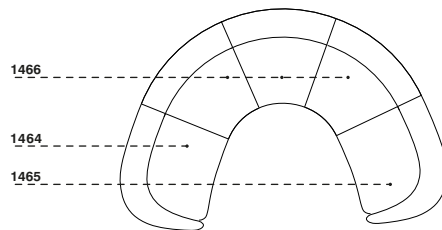

APP06

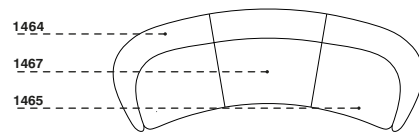

APP07

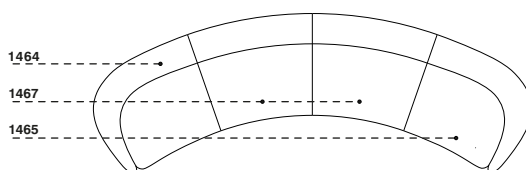

APP08

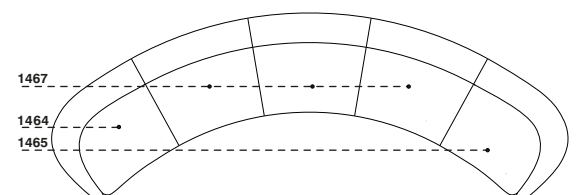

APP09

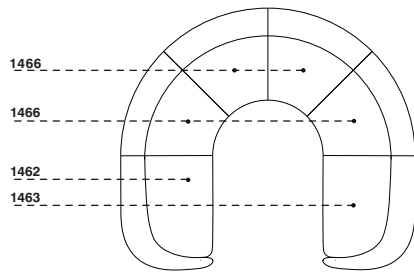

APP10

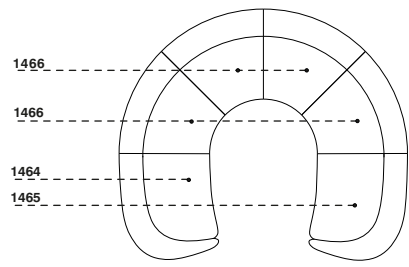

APP11

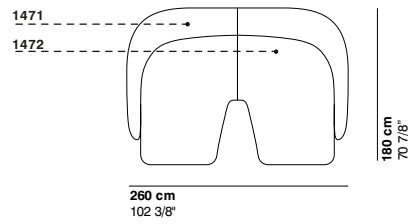

APP12

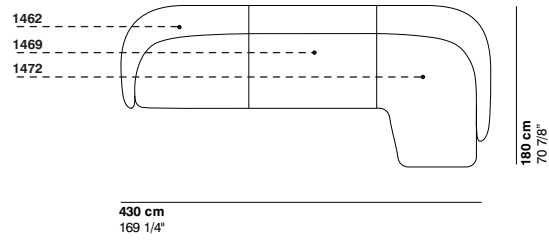

APP13

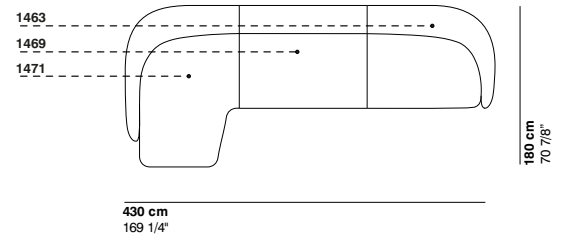

La Cividina s.r.l., al fine di migliorare le caratteristiche tecniche e qualitative della sua produzione, si riserva di apportare, anche senza preavviso, tutte le modifiche che si rendessero necessarie.

With a view to improving the technical characteristics and quality of its products La Cividina s.r.l. reserves the right to develop its products at anytime without notice.

A fin d'améliorer les caractéristiques de sa production, La Cividina s.r.l. se réserve d'apporter, même sans préavis, toutes les modifications qui se rendent nécessaires.

Zur Verbesserung, der technischen und qualitativen Merkmale, behält sich La Cividina s.r.l. vor, alle notwendig erscheinenden Produktionsänderungen, auch ohne Vorankündigung durchzuführen.

LA CIVIDINA S.R.L.

HEADQUARTERS / PRODUCTION

Via Spilimbergo 162
33035 Martignacco
Udine Italy
T +39 0432 677433
F +39 0432 677480
info@lacidina.com
lacidina.com

ISO 9001



SHOWROOM MARTIGNACCO

Via Lungolavia 1
33035 Martignacco
Udine Italy
T +39 0432 677433

SHOWROOM MILANO

Palazzo Borromeo
Via Manzoni 41
20121 Milano
Italy
T +39 345 8350810