

# SUSHI

Armchair, Sofa, Ottoman  
Bench, System

Mauro Fadel,  
2002

laCividina



**DATI TECNICI**  
**TECHNICAL DATA**  
**DONNÉES TECHNIQUES**  
**TECHNISCHE ANGABEN**

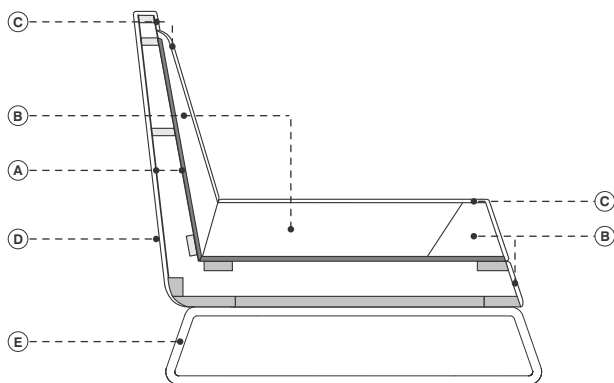

- |   |  |   |   |
|---|--|---|---|
| ■ Legno massiccio di abete  | ■ Solid fir  | ■ Bois de sapin massif  | ■ Massivholz aus Tanne  |
| ■ Legno massiccio di faggio   | ■ Solid beech  | ■ Bois de hêtre massif  | ■ Massivholz aus Buche  |
| ■ Multistrato di faggio   | ■ Multilayered beech   | ■ Multiplis de hêtre  | ■ Buchenschichtholz   |
| A. Pannello di masonite   | A. Masonite panels   | A. Panneau de particules  | A. Holzfaserplatte  |
| B. Poliuretano espanso ignifugo indeformabile a quote differenziate | B. Flame-retardant undeformable polyurethane foam of different densities | B. Mousse polyuréthane expansé ignifuge indéformable à épaisseurs différenciées | B. Feuerfester formbeständige Polyurethanschaum in unterschiedlicher Dichte |
| C. Fibra di poliestere  | C. Polyester fibers  | C. Fibre de polyester   | C. Polyester  |
| D. Rivestimento fisso in tessuto o pelle                            | D. Fixed upholstery in fabric or leather                                 | D. Revêtement pas déhoussable en tissu ou cuir                                  | D. Unabziehbarer Bezug aus Stoff oder Leder                                 |
| E. Acciaio  | E. Steel   | E. Acier  | E. Stahl  |

**NOTE**  
**NOTES**  
**ANNOTATION**  
**ANMERKUNG**

- |   |   |   |   |
|---|---|---|---|
| <ul style="list-style-type: none"> <li>■ Base personalizzabile con tinta cliente</li> <li>■ Prodotto disponibile su misura con preventivo su richiesta</li> <li>■ Su richiesta attacco per connessione elettrica e USB con sovrapprezzo</li> <li>■ Cuscini extra disponibili</li> <li>■ COM: tessuto cliente (tinta unita e h.140 cm.) - campione richiesto</li> <li>■ COL: pelle cliente - campione richiesto</li> </ul> | <ul style="list-style-type: none"> <li>■ Base customizable with customer's colors on request</li> <li>■ This item can be tailor made with price on request</li> <li>■ Electrical connection and USB upon request with upcharge</li> <li>■ Extra cushions available</li> <li>■ COM: client's fabric (plain colour and width 140 cm.) - sample required</li> <li>■ COL: client's leather - sample required</li> </ul> | <ul style="list-style-type: none"> <li>■ Piètement disponible en autres finitions sur demande</li> <li>■ Collection personnalisable sur demande</li> <li>■ Sur demande connection électrique et USB avec surcoût</li> <li>■ Autres coussins disponibles</li> <li>■ COM: tissu fourni (couleur unie et hauteur 140 cm.) - échantillon nécessaire</li> <li>■ COL: cuir fourni - échantillon nécessaire</li> </ul> | <ul style="list-style-type: none"> <li>■ Gestell in Kundenfarben auf Anfrage verfügbar</li> <li>■ Produkt nach Maß verfügbar auf Anfrage</li> <li>■ Elektrische Verbindung und USB-Anschluss auf Anfrage gegen Aufpreis</li> <li>■ Weitere Kissen verfügbar</li> <li>■ COM: Kundenstoff (einfarbig und Breite 140 cm.) - Stoffmuster nötig</li> <li>■ COL: Kundenleder - Ledermuster nötig</li> </ul> |
|---|---|---|---|

**OPZIONE**  
**OPZION**  
**OPTION**  
**OPTION**



Su richiesta attacco per connessione elettrica e USB con sovrapprezzo  
 Electrical connection and USB upon request with upcharge  
 Sur demande connection électrique et USB avec surcoût  
 Elektrische Verbindung und USB-Anschluss auf Anfrage gegen Aufpreis

**SISTEMA DI AGGANCIAMENTO**  
**SYSTEM CONNECTOR**  
**SYSTEME D'ASSEMBLAGE**  
**VERBINDUNGSHAKEN**



Sistema di aggancio tra elementi  
 Components connector  
 Systeme d'assemblage de socle  
 Verbindungssystem zwischen Elemente

**FINITURA BASE**  
**BASE FINISHES**  
**FINITIONS PIETEMENT**  
**GESTELL AUSFUHRUNGEN**



Cromato lucido  
 Polished chrome steel  
 Acier chromé brillant  
 Stahl Chrom poliert



Nero (RAL 9005)  
 Black (RAL 9005)  
 Noir (RAL 9005)  
 Schwarz (RAL 9005)

**RIVESTIMENTI CONSIGLIATI**  
**RECOMMENDED COVERINGS**  
**REVÊTEMENTS CONSEILLÉS**  
**EMPFOHLENE BEZÜGE**

**CAT. START**  
 RINGO  
 OPUS

**CAT. A**  
 XTREME  
 TAILOR  
 ANGEL  
 MEDLEY  
 SAMAR  
 AVON  
 MAGNUM  
 AUTUMN  
 HANGO

**CAT. B**  
 FAME  
 MAIN LINE FLAX  
 HESTAN  
 SILVERTEX  
 GEIKO

**CAT. C**  
 SUPERB  
 TREND  
 KEN BI  
 MIKONOS  
 ANDROS  
 ACAPULCO

**CAT. SUPER**  
 ORSETTO  
 REMIX 3  
 MYLLA  
 TWISTED FLOWER  
 DHARMA DIS.400  
 DHARMA DIS.200  
 DHARMA DIS.600  
 DHARMA DIS.100  
 DHARMA DIS.500  
 DIVA DIS.01

**CAT. EXTRA**  
 STEELCUT TRIO 3  
 ARIANA  
 OPERA  
 ARCO  
 CREDO  
 TRIO  
 BIT  
 DIVA DIS.05  
 DIVA DIS.21  
 DIVA DIS.29

**CAT.MAXI**  
 UNIFORM MÉLANGE  
 HALLINGDAL 65  
 DIVINA 3

**CAT. TOP**  
 ARDA  
 REGOS

**CAT. SPECIAL**  
 GENTLE 2

**CAT. LUX**  
 LUX 1  
 LUX 2

**CAT. IMPERIAL**  
 IMPERIAL 1  
 IMPERIAL 2

**MODULI SEDUTA  
SEAT MODULES  
MODULES DE SIÈGES  
SITZMODULE**

**COD. 4001N**  
ELEMENT 60

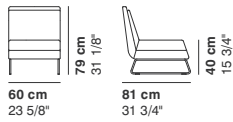

**COD. 4002N**  
ELEMENT 90

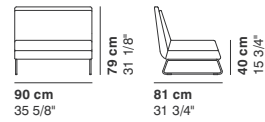

**COD. 4003**  
ELEMENT 120

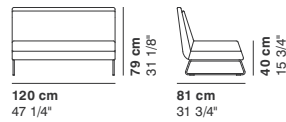

**COD. 4004N**  
ELEMENT 150

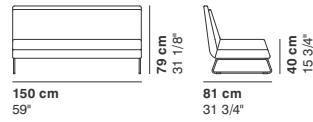

**COD. 4005N**  
ELEMENT 200

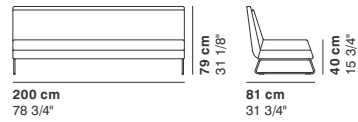

**COD. 4006N**  
ELEMENT 250

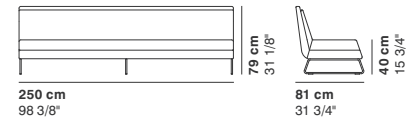

**POUF  
OTTOMAN  
POUF  
HOCKER**

**COD. 4007N**  
OTTOMAN 60

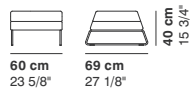

**COD. 4008N**  
OTTOMAN 90

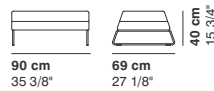

**COD. 4009N**  
OTTOMAN 120

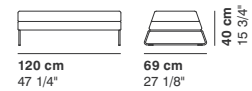

**PANCA  
BENCH  
BANQUETTE  
BANK**

**COD. 4010N**  
BENCH 150

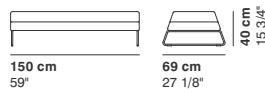

**COD. 4011N**  
BENCH 200



**COD. 4012N**  
OPEN ELEMENT CURVED 100

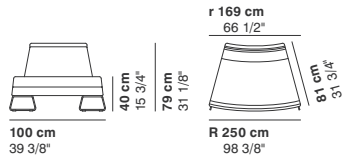

**COD. 4013N**  
CLOSED ELEMENT CURVED 100

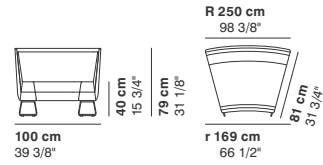

**COD. 4014N**  
OPEN ELEMENT CURVED 200

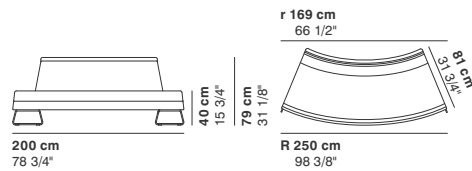

**COD. 4015N**  
CLOSED ELEMENT CURVED 200

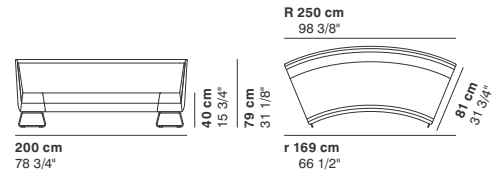

**COD. 4016N**  
CLOSED ELEMENT CURVED 90°

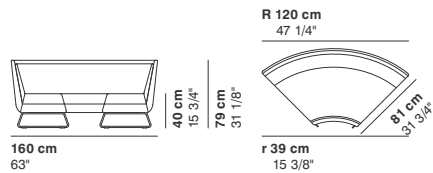

**COD. 4017N**  
OPEN ELEMENT CURVED 90°

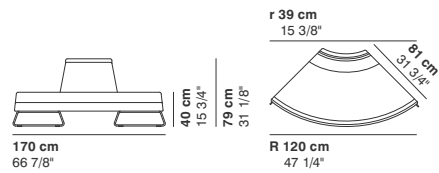

**COD. 4018N**  
CLOSED OTTOMAN CURVED 90°

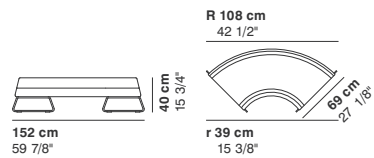

**COD. 4020N**  
OPEN OTTOMAN CURVED 90°

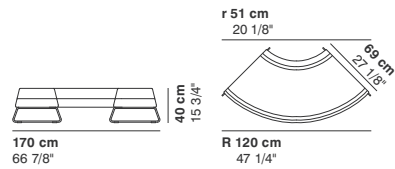

**COD. 4019N**  
CLOSED OTTOMAN CURVED 188

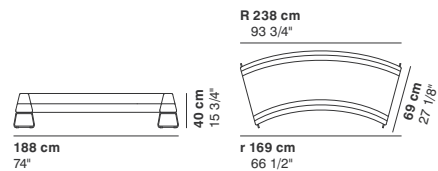

**COD. 4021N**  
OPEN OTTOMAN CURVED 200

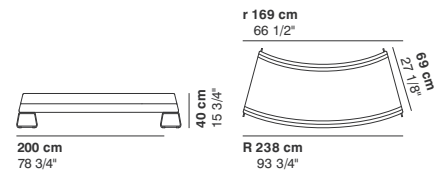

**COD. SUS01**  
COMPOSITION

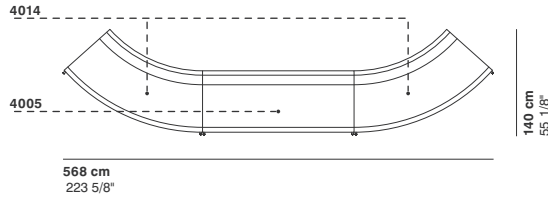

**COD. SUS02**  
COMPOSITION

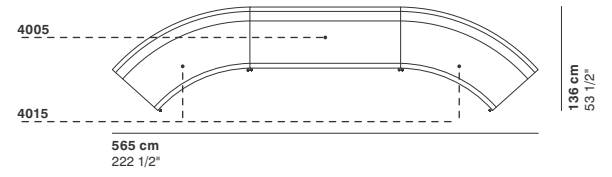

**COD. SUS03**  
COMPOSITION

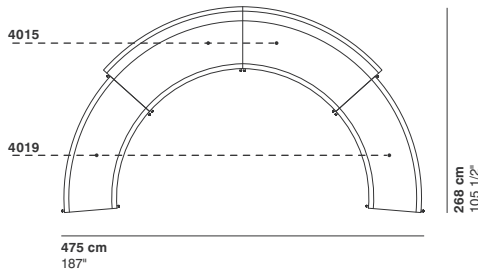

**COD. SUS04**  
COMPOSITION

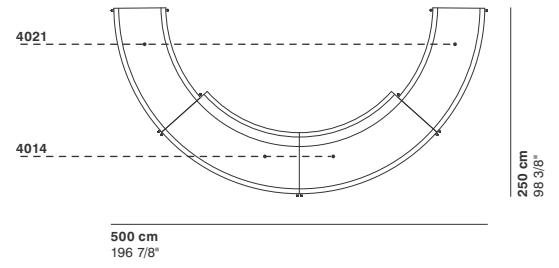

**COD. SUS05**  
COMPOSITION

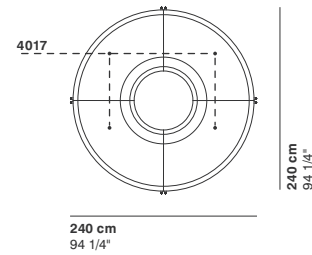

**COD. SUS06**  
COMPOSITION

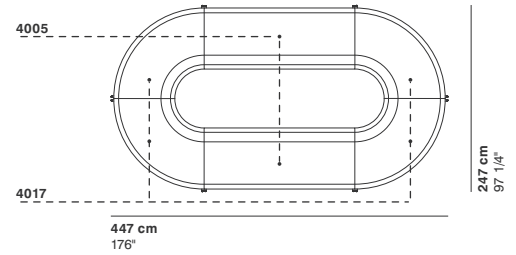

**COD. SUS07**  
COMPOSITION

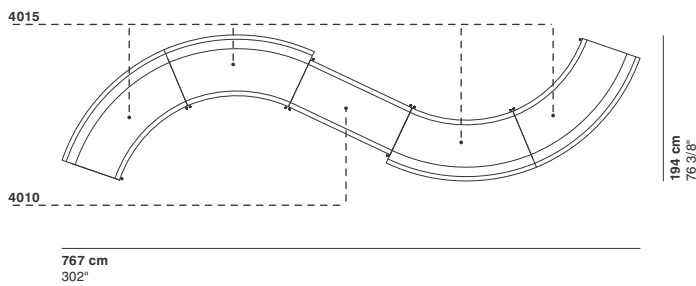

**COD. SUS08**  
COMPOSITION

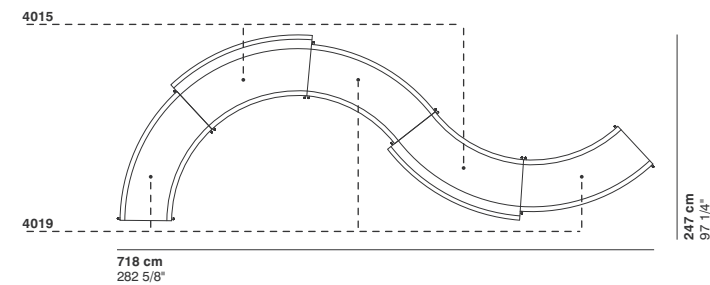

---

La Cividina s.r.l., al fine di migliorare le caratteristiche tecniche e qualitative della sua produzione, si riserva di apportare, anche senza preavviso, tutte le modifiche che si rendessero necessarie.

With a view to improving the technical characteristics and quality of its products la Cividina s.r.l. reserves the right to develop its products at anytime without notice.

A fin d'améliorer les caractéristiques de sa production, La Cividina s.r.l. se réserve d'apporter, même sans préavis, toutes les modifications qui se rendent nécessaires.

Zur Verbesserung, der technischen und qualitativen Merkmale, behält sich La Cividina s.r.l. vor, alle notwending erscheinenden Produktionsänderungen, auch ohne Vorankündigung durchzuführen.

---

**LA CIVIDINA S.R.L.**

**HEADQUARTERS / PRODUCTION**

Via Spilimbergo 162  
33035 Martignacco  
Udine Italy  
T +39 0432 677433  
F +39 0432 677480  
[info@lacividina.com](mailto:info@lacividina.com)  
[lacividina.com](http://lacividina.com)

**ISO 9001**



**SHOWROOM MARTIGNACCO**

Via Lungolavia 1  
33035 Martignacco  
Udine Italy  
T +39 0432 677433

**SHOWROOM MILANO**

Palazzo Borromeo  
Via Manzoni 41  
20121 Milano  
Italy  
T +39 345 8350810