

SOAVE

Armchair, Sofa

Sebastian Herkner,
2018

laCividina



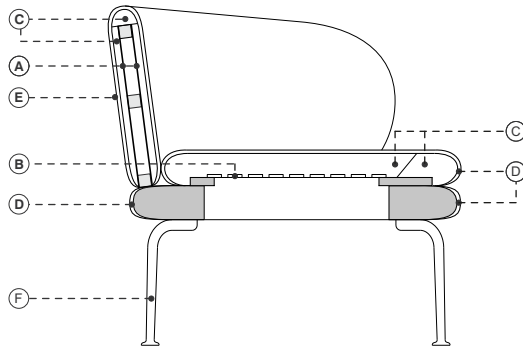

- | | | | |
|--|---|--|---|
| ■ Legno massiccio di abete | ■ Solid fir | ■ Bois de sapin massif | ■ Massiveholz aus Tanne |
| ■ Legno massiccio di faggio | ■ Solid beech | ■ Bois de hêtre massif | ■ Massivholz Buche |
| A. Pannello di masonite | A. Masonite panels | A. Panneau de particules | A. Holzfaserplatte |
| B. Cinghie elastiche ad alta densità | B. High density elastic straps | B. Sangles élastiques à haute densité | B. Elastische Gurtbänder |
| C. Poliuretano espanso ignifugo indeformabile a quote differenziate | C. Flame-retardant undeformable polyurethane foam of different densities | C. Mousse polyuréthane expansé ignifuge indéformable à épaisseurs différenciées | C. Feuerfester formbeständiger Polyurethanschaum in unterschiedlicher Dichte |
| D. Fibra di poliestere | D. Polyester fibers | D. Fibre de polyester | D. Polyester |
| E. Rivestimento fisso in tessuto o pelle | E. Fixed upholstery in fabric or leather | E. Revêtement pas déhoussable en tissu ou cuir | E. Unabziehbarer Bezug aus Stoff oder Leder |
| F. Acciaio verniciato | F. Lacquered steel | F. Acier laqué | F. Lackierter Stahl |

NOTE
NOTES
ANNOTATION
ANMERKUNG

- | | | | |
|---|---|--|---|
| ■ Piedi personalizzabili con tinta cliente | ■ Feet customizable with customer's colors on request | ■ Pieds personnalisable avec coloris du sur demande | ■ Füße in Kundenfarben auf Anfrage verfügbar |
| ■ Cuscini extra disponibili | ■ Extra cushions available | ■ Autres coussins disponibles | ■ Weitere Kissen verfügbar |
| ■ COM: tessuto cliente (tinta unita e h.140 cm.) - campione richiesto | ■ COM: client's fabric (plain colour and width 140 cm.) - sample required | ■ COM: tissu fourni (couleur unie et hauteur 140 cm.) - échantillon nécessaire | ■ COM: Kundenstoff (einfarbig und Breite 140 cm.) - Stoffmuster nötig |
| ■ COL: pelle cliente - campione richiesto | ■ COL: client's leather - sample required | ■ COL: cuir fourni - échantillon nécessaire | ■ COL: Kundenleder - Ledermuster nötig |

densities

FINITURE PIEDI
FEET FINISHES
FINITIONS DE PIEDS
FÜSSE AUSFÜHRUNGEN



Nero pece
 Pitch black
 Poix noir
 Pech Schwarz



Prugna
 Plum
 Prune
 Pflaume



Laccato ottone
 Lacquered brass
 Laqué laiton
 Messing lackiert



Laccato rame
 Lacquered copper
 Laqué cuivre
 Kupfer lackiert

FINITURE PIANO TAVOLO
TABLES TOP FINISHES
FINITIONS DE PLATEAU DE TABLE
TISCHPLATTEN AUSFÜHRUNGEN



Rovere spazzolato naturale
 Natural brushed oak
 Chêne brossé naturel
 Eichenholz Natural gebürstet



Rovere spazzolato grafite
 Graphite brushed oak
 Chêne brossé graphite
 Eichenholz Graphit gebürstet



MDF Bianco (RAL 9016)
 MDF White (RAL 9016)
 MDF Blanc (RAL 9016)
 MDF Weiß (RAL 9016)



MDF Nero (RAL 9005)
 MDF Black (RAL 9005)
 MDF Noir (RAL 9005)
 MDF Schwarz (RAL 9005)



Ma Marquina
 Marquina marble
 Marbre Marquina
 Marquina Marmor



Marmo Carrara
 Carrara marble
 Marbre Carrara
 Carrara Marmor



Marmo Calacatta
 Calacatta marble
 Marbre Calacatta
 Calacatta Marmor

RIVESTIMENTI CONSIGLIATI
RECCOMENDED COVERINGS
REVÊTEMENTS CONSEILLÉS
EMPFOHLENE BEZÜGE

CAT. START
RINGO
OPUS

CAT. A
XTREME
TAILOR
ANGEL
MEDLEY
SAMAR
AVON
MAGNUM
AUTUMN
HANGO

CAT. B
FAME
MAIN LINE FLAX
HESTAN
SILVERTEX
GEIKO

CAT. C
SUPERB
TREND
KEN BI
MIKONOS
ANDROS
ACAPULCO

CAT. SUPER
ORSETTO
REMIX 3
MYLLA
TWISTED FLOWER
DHARMA DIS.400
DHARMA DIS.200
DHARMA DIS.600
DHARMA DIS.100
DHARMA DIS.500
DIVA DIS.01

CAT. EXTRA
STEELCUT TRIO 3
ARIANA
OPERA
ARCO
CREDO
TRIO
BIT
DIVA DIS.05
DIVA DIS.21
DIVA DIS.29

CAT.MAXI
UNIFORM MÉLANGE
HALLINGDAL 65
DIVINA 3

CAT. TOP
ARDA
REGOS

CAT. SPECIAL
GENTLE 2

CAT. LUX
LUX 1
LUX 2

CAT. IMPERIAL
IMPERIAL 1
IMPERIAL 2

POLTRONA
ARMCHAIR
FAUTEUIL
SESSEL

COD. 1030N
ARMCHAIR

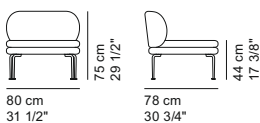

COD. 1031N
ARMCHAIR WITH ARMS

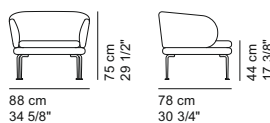

COD. 1031N
HIGH ARMCHAIR

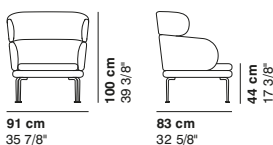

DIVANI
SOFAS
CANAPÉS
SOFAS

COD. 1032N
2 SEATER

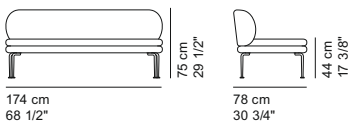

COD. 1033N
2 SEATER WITH ARMS

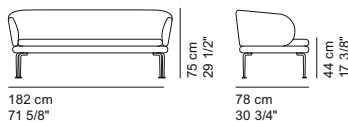

COD. 1034N
3 SEATER

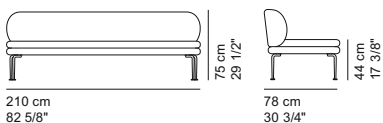

COD. 1035N
3 SEATER WITH ARMS

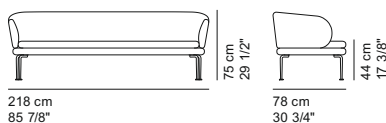

COD. 1036N
RIGHT ELEMENT 178

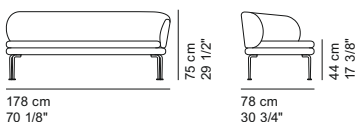

COD. 1037N
LEFT ELEMENT 178

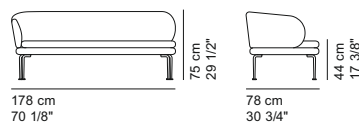

COD. 1038N
RIGHT ELEMENT 214

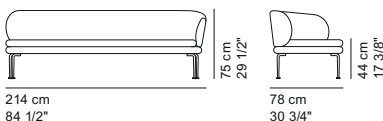

COD. 1039N
LEFT ELEMENT 214

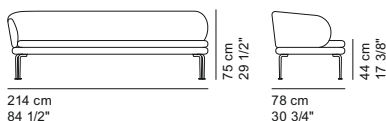

COD. 1040N
ELEMENT 174 WITH RIGHT TABLE

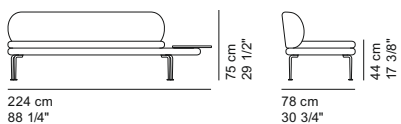

COD. 1041N
ELEMENT 174 WITH LEFT TABLE

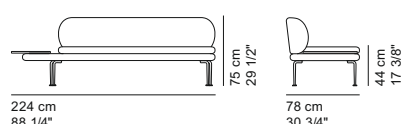

COD. 1034N
3 SEATER

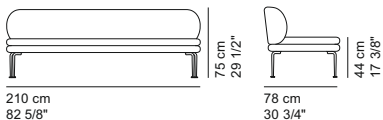

COD. 1035N
3 SEATER WITH ARMS

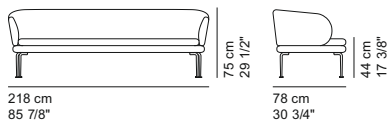

COD. 1036N
RIGHT ELEMENT 178

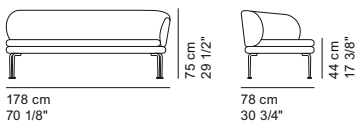

COD. 1037N
LEFT ELEMENT 178

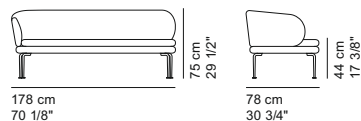

COD. 1038N
RIGHT ELEMENT 214

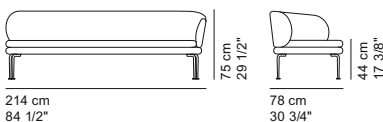

COD. 1039N
LEFT ELEMENT 214

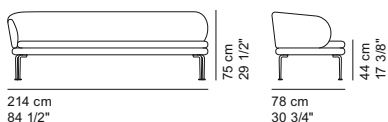

COD. 1040N
ELEMENT 174 WITH RIGHT TABLE

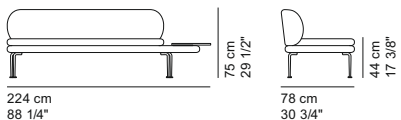

COD. 1041N
ELEMENT 174 WITH LEFT TABLE

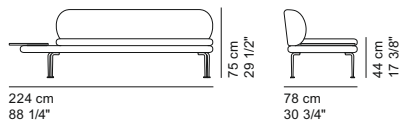

COD. 1042N
ELEMENT 178 WITH LEFT TABLE

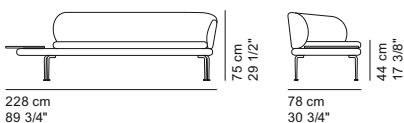

COD. 1043N
ELEMENT 178 WITH RIGHT TABLE

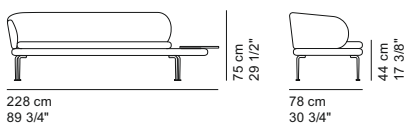

COD. 1033N HIGH
HIGH 2 SEATER

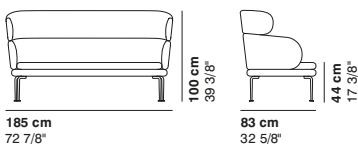

COD. 1035N HIGH
HIGH 3 SEATER

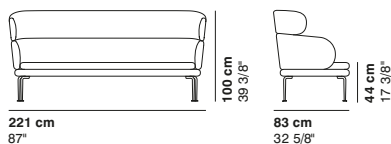

La Cividina s.r.l., al fine di migliorare le caratteristiche tecniche e qualitative della sua produzione, si riserva di apportare, anche senza preavviso, tutte le modifiche che si rendessero necessarie.

With a view to improving the technical characteristics and quality of its products La Cividina s.r.l. reserves the right to develop its products at anytime without notice.

A fin d'améliorer les caractéristiques de sa production, La Cividina s.r.l. se réserve d'apporter, même sans préavis, toutes les modifications qui se rendent nécessaires.

Zur Verbesserung, der technischen und qualitativen Merkmale, behält sich La Cividina s.r.l. vor, alle notwendig erscheinenden Produktionsänderungen, auch ohne Vorankündigung durchzuführen.

LA CIVIDINA S.R.L.

HEADQUARTERS / PRODUCTION

Via Spilimbergo 162
33035 Martignacco
Udine Italy
T +39 0432 677433
F +39 0432 677480
info@lacividina.com
lacividina.com

ISO 9001



SHOWROOM MARTIGNACCO

Via Lungolavia 1
33035 Martignacco
Udine Italy
T +39 0432 677433

SHOWROOM MILANO

Palazzo Borromeo
Via Manzoni 41
20121 Milano
Italy
T +39 345 8350810