

PUZZLE

Armchair, Sofa, Dormeuse, Ottoman, System

Fulvio Bulfoni,
1996

laCividina



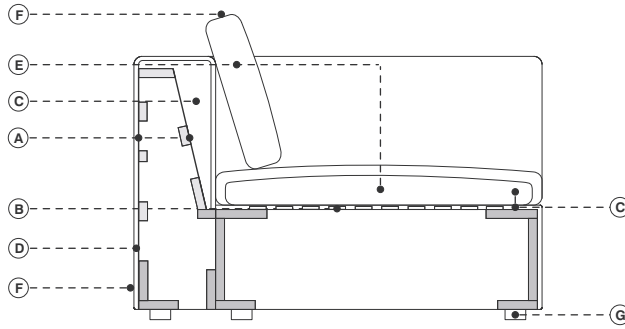

- | | | | |
|--|---|--|--|
| ■ Legno massiccio di abete | ■ Solid fir | ■ Bois de sapin massif | ■ Massivholz aus Tanne |
| ■ Legno massiccio di faggio | ■ Solid beech | ■ Bois de hêtre massif | ■ Massivholz aus Buche |
| A. Pannello di masonite | A. Masonite panels | A. Panneau de particules | A. Holzfaserplatte |
| B. Cinghie elastiche ad alta densità | B. High density elastic straps | B. Sangles élastiques | B. Elastischen Gurtbändern |
| C. Poliuretano espanso ignifugo indeformabile a quote differenziate | C. Flame-retardant undeformable polyurethane foam of different densities | C. Mousse polyuréthane expansé ignifuge indéformable à épaisseurs différenciées | C. Feuerfester formbeständige Polyurethanschaum in unterschiedlicher Dichte |
| D. Fibra di poliestere | D. Polyester fibers | D. Fibre de polyester | D. Polyester |
| E. Piuma e fibra di poliestere elicoidale | E. Feathers and helical polyester fibers | E. Plume et fibre de polyester hélicoïdal | E. Daunen und Polyesterfaser spiralförmig |
| F. Rivestimento sfoderabile in tessuto e non sfoderabile in pelle o finta pelle | F. Removable upholstery in fabric and non-removable in leather or artificial leather | F. Revêtement déhoussable en tissu pas déhoussable en simili cuir et cuir | F. Stoffbezug abziehbar; Leder- und Kunstlederbezug unabziehbar |
| G. Polipropilene nero | G. Black polypropylene | G. Polypropylène noir | G. Schwarz Polypropylen |

NOTE
NOTES
ANNOTATION
ANMERKUNG

- | | | | |
|---|---|--|---|
| ■ Prodotto disponibile su misura con preventivo su richiesta | ■ This item can be tailor made with price on request | ■ Collection personnalisable sur demande | ■ Sonderprodukt auf Anfrage verfügbar |
| ■ Su richiesta attacco per connessione elettrica e USB con sovrapprezzo | ■ Electrical connection and USB upon request with upcharge | ■ Sur demande connection électrique et USB avec surcoût | ■ Elektrische Verbindung und USB-Anschluss auf Anfrage gegen Aufpreis |
| ■ Cuscini extra disponibili | ■ Extra cushions available | ■ Autres coussins disponibles | ■ Weitere Kissen verfügbar |
| ■ COM: tessuto cliente (tinta unita e h.140 cm.) - campione richiesto | ■ COM: client's fabric (plain colour and width 140 cm.) - sample required | ■ COM: tissu fourni (couleur unie et hauteur 140 cm.) - échantillon nécessaire | ■ COM: Kundenstoff (einfarbig und Breite 140 cm.) - Stoffmuster nötig |
| ■ COL: pelle cliente - campione richiesto | ■ COL: client's leather - sample required | ■ COL: cuir fourni - échantillon nécessaire | ■ COL: Kundenleder - Ledermuster nötig |

SISTEMA DI AGGANCIAMENTO
SYSTEM CONNECTOR
SYSTEME D'ASSEMBLAGE
VERBINDUNGSHAKEN



Sistema di aggancio sedile-schienale
 Seat and back connector
 Systeme d'assemblage pour dossier
 Verbindungshaken für Sitz und Rücken



Sistema di aggancio tra elementi
 Components connector
 Systeme d'assemblage de socle
 Verbindungssystem zwischen Elemente

OPZIONE
OPTION
OPTION
OPZION



Su richiesta attacco per connessione elettrica e USB con sovrapprezzo
 Electrical connection and USB upon request with upcharge
 Sur demande connection électrique et USB avec surcoût
 Elektrische Verbindung und USB-Anschluss auf Anfrage gegen Aufpreis

RIVESTIMENTI CONSIGLIATI
RECOMMENDED COVERINGS
REVÊTEMENTS CONSEILLÉS
EMPFOHLENE BEZÜGE

CAT. START
 RINGO
 OPUS

CAT. A
 XTREME
 TAILOR
 ANGEL
 MEDLEY
 SAMAR
 AVON
 MAGNUM
 AUTUMN
 HANGO

CAT. B
 FAME
 MAIN LINE FLAX
 HESTAN
 SILVERTEX
 GEIKO

CAT. C
 SUPERB
 TREND
 KEN BI
 MIKONOS
 ANDROS
 ACAPULCO

CAT. SUPER
 ORSETTO
 REMIX 3
 MYLLA
 TWISTED FLOWER
 DHARMA DIS.400
 DHARMA DIS.200
 DHARMA DIS.600
 DHARMA DIS.100
 DHARMA DIS.500
 DIVA DIS.01

CAT. EXTRA
 STEELCUT TRIO 3
 ARIANA
 OPERA
 ARCO
 CREDO
 TRIO
 BIT
 DIVA DIS.05
 DIVA DIS.21
 DIVA DIS.29

CAT.MAXI
 UNIFORM MÉLANGE
 HALLINGDAL 65
 DIVINA 3

CAT. TOP
 ARDA
 REGOS

CAT. SPECIAL
 GENTLE 2

CAT. LUX
 LUX 1
 LUX 2

CAT. IMPERIAL
 IMPERIAL 1
 IMPERIAL 2

**POLTRONE
ARMCHAIRS
FAUTEUILS
SESSELS**

COD. 5202
SMALL ARMCHAIR

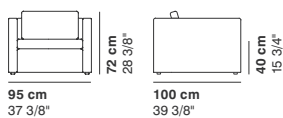

COD. 5203
BIG ARMCHAIR

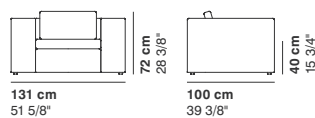

**DIVANI
SOFAS
CANAPÉS
SOFAS**

COD. 5204
SMALL 2 SEATER SOFA

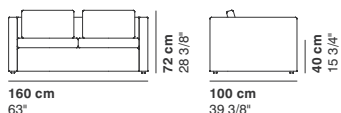

COD. 5205
BIG 2 SEATER SOFA

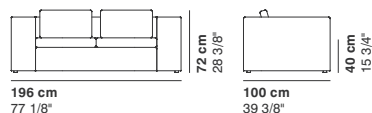

COD. 5206
SMALL 2 SEATER SOFA MAJOR

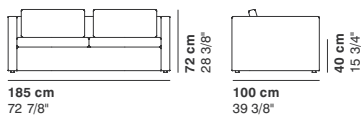

COD. 5207
BIG 2 SEATER SOFA MAJOR

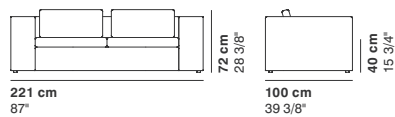

COD. 5208
SMALL 3 SEATER SOFA

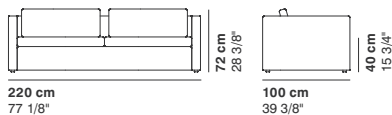

COD. 5209
BIG 3 SEATER SOFA

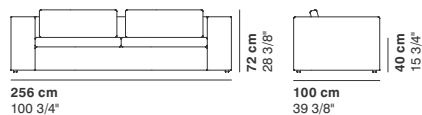

**COMPONIBILI
SYSTEM
CANAPÉS MODULAIRES
MODULAR SOFAS**

COD. 5210
ELEMENT SMALL 85 DX

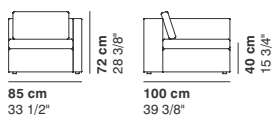

COD. 5212
ELEMENT SMALL 85 SX

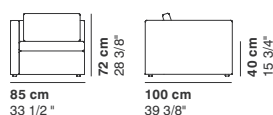

COD. 5211
ELEMENT BIG 103 RIGHT

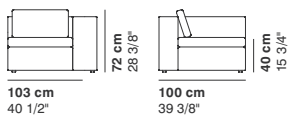

COD. 5213
ELEMENT BIG 103 LEFT

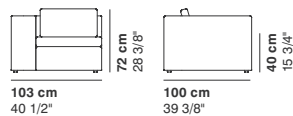

COD. 5214
ELEMENT SMALL 150 RIGHT

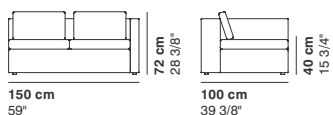

COD. 5216
ELEMENT SMALL 150 LEFT

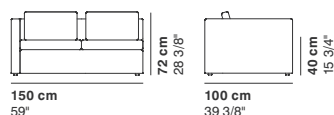

COD. 5215
ELEMENT BIG 168 RIGHT

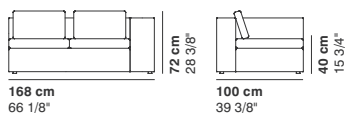

COD. 5217
ELEMENT BIG 168 LEFT

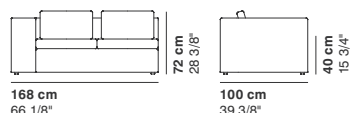

COD. 5218
SMALL RIGHT ELEMENT 210

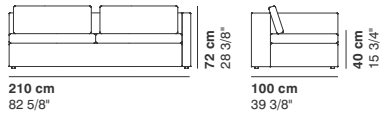

COD. 5220
SMALL LEFT ELEMENT 210

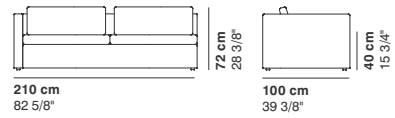

COD. 5219
BIG RIGHT ELEMENT 228

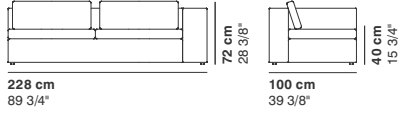

COD. 5221
BIGLEFT ELEMENT 228

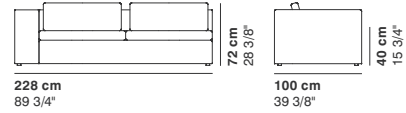

COD. 5222
SMALL RIGHT DORMEUSE

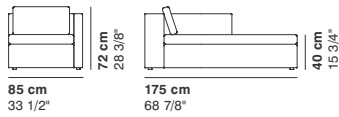

COD. 5224
SMALL LEFT DORMEUSE

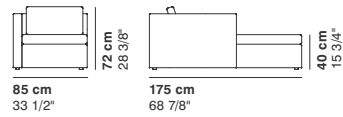

COD. 5223
RIGHT BIG DORMEUSE

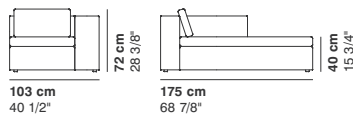

COD. 5225
LEFT BIG DORMEUSE

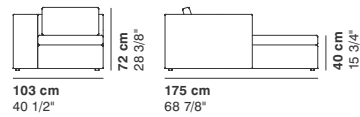

COD. 5226
CORNER

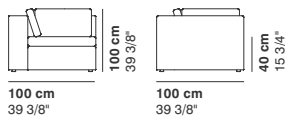

COD. 5233
ELEMENT 75

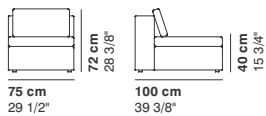

COD. 5238
ELEMENT 100

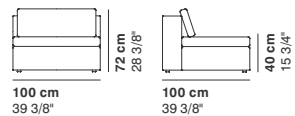

COD. 5234
ELEMENT 140

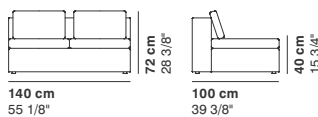

COD. 5235
ELEMENT 200

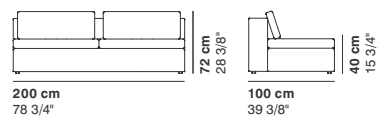

COD. 5236
ELEMENT DORMEUSE 75

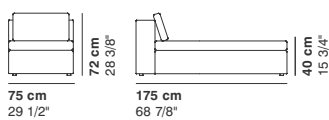

COD. 5237
ELEMENT DORMEUSE 100

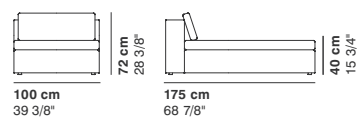

POUF
OTTOMAN
POUF
HOCKER

COD. 5227
OTTOMAN 75X75

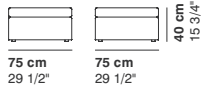

COD. 5228
OTTOMAN 100X100

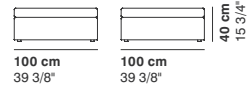

COD. 5229
OTTOMAN 75X140

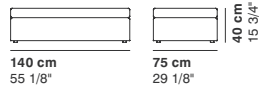

COD. 5230
OTTOMAN 75X200

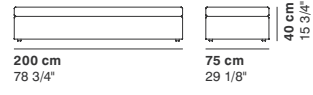

La Cividina s.r.l., al fine di migliorare le caratteristiche tecniche e qualitative della sua produzione, si riserva di apportare, anche senza preavviso, tutte le modifiche che si rendessero necessarie.

With a view to improving the technical characteristics and quality of its products la Cividina s.r.l. reserves the right to develop its products at anytime without notice.

A fin d'améliorer les caractéristiques de sa production, La Cividina s.r.l. se réserve d'apporter, même sans préavis, toutes les modifications qui se rendent nécessaires.

Zur Verbesserung, der technischen und qualitativen Merkmale, behält sich La Cividina s.r.l. vor, alle notwendig erscheinenden Produktionsänderungen, auch ohne Vorankündigung durchzuführen.

LA CIVIDINA S.R.L.

HEADQUARTERS / PRODUCTION

Via Spilimbergo 162
33035 Martignacco
Udine Italy
T +39 0432 677433
F +39 0432 677480
info@lacividina.com
lacividina.com

ISO 9001



SHOWROOM MARTIGNACCO

Via Lungolavia 1
33035 Martignacco
Udine Italy
T +39 0432 677433

SHOWROOM MILANO

Palazzo Borromeo
Via Manzoni 41
20121 Milano
Italy
T +39 345 8350810