

MANHATTAN

Armchair, Sofa, Dormeuse, Ottoman, System

Fulvio Bulfoni,
1996

laCividina



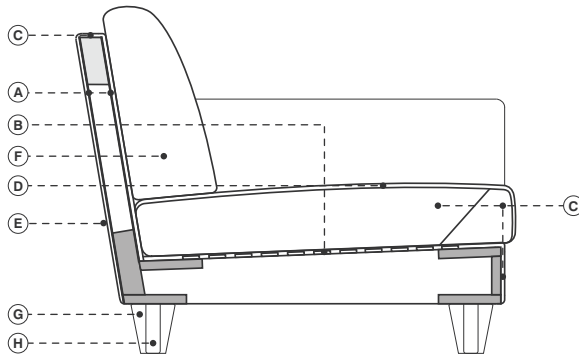

- | | | | |
|--|---|--|--|
| ■ Legno massiccio di abete | ■ Solid fir | ■ Bois de sapin massif | ■ Massivholz aus Tanne |
| ■ Legno massiccio di faggio | ■ Solid beech | ■ Bois de hêtre massif | ■ Massivholz aus Buche |
| A. Pannelli di masonite | A. Masonite panels | A. Panneau de particules | A. Holzfaserplatte |
| B. Cinghie elastiche ad alta densità | B. High density elastic straps | B. Sangles élastiques | B. Elastischen Gurtbändern |
| C. Poliuretano espanso ignifugo indeformabile a quote differenziate | C. Flame-retardant undeformable polyurethane foam of different densities | C. Mousse polyuréthane expansé ignifuge indéformable à épaisseurs différenciées | C. Feuerfester formbeständige Polyurethanschaum in unterschiedlicher Dichte |
| D. Fibra di poliestere | D. Polyester fibers | D. Fibre de polyester | D. Polyester |
| E. Rivestimento sfoderabile in tessuto e non sfoderabile in pelle e finta pelle | E. Removable upholstery in fabric and fixed in leather or artificial leather | E. Revêtement déhoussable en tissu et pas déhoussable en cuir ou simili cuir | E. Abziehbarer Bezug aus Stoff oder unabziehbarer aus Leder und Kunstleder |
| F. Piuma e fibra di poliestere elicoidale | F. Feathers and helical polyester fibers | F. Plume et fibre de polyester hélicoïdal | F. Daunen und Polyesterfaser spiralförmig |
| G. Legno di faggio | G. Beech wood | G. Bois de hêtre | G. Buchenholz |
| H. Alluminio | H. Aluminium | H. Aluminium | H. Aluminium |

NOTE
NOTES
ANNOTATION
ANMERKUNG

- | | | | |
|---|---|--|---|
| ■ Piedi personalizzabili con tinta cliente | ■ Feet customizable with customer's colors on request | ■ Pieds personnalisable avec coloris du sur demande | ■ Füße in Kundenfarben auf Anfrage verfügbar |
| ■ Prodotto disponibile su misura con preventivo su richiesta | ■ This item can be tailor made with price on request | ■ Collection personnalisable sur demande | ■ Produkt nach Maß verfügbar auf Anfrage |
| ■ Su richiesta attacco per connessione elettrica e USB con sovrapprezzo | ■ Electrical connection and USB on request with upcharge | ■ Sur demande connection électrique et USB avec surcoût | ■ Elektrische Verbindung und USB-Anschluss auf Anfrage gegen Aufpreis |
| ■ Cuscini extra disponibili | ■ Extra cushions available | ■ Autres coussins disponibles | ■ Weitere Kissen verfügbar |
| ■ COM: tessuto cliente (tinta unita e h.140 cm.) - campione richiesto | ■ COM: client's fabric (plain colour and width 140 cm.) - sample required | ■ COM: tissu fourni (couleur unie et hauteur 140 cm.) - échantillon nécessaire | ■ COM: Kundenstoff (einfarbig und Breite 140 cm.) - Stoffmuster nötig |
| ■ COL: pelle cliente - campione richiesto | ■ COL: client's leather - sample required | ■ COL: cuir fourni - échantillon nécessaire | ■ COL: Kundenleder - Ledermuster nötig |

FINITURE IN LEGNO
WOODEN FINISHES
FINITIONS BOIS
HOLZ AUSFÜHRUNGEN



Faggio naturale
 Natural beech
 Hêtre naturel
 Buchenholz Naturfarbe



Faggio tinto noce
 Walnut-stained beech
 Hêtre teinté noyer
 Buchenholz Nussbaum gebeizt

SISTEMA DI AGGANCIO
SYSTEM CONNECTOR
SYSTEME D'ASSEMBLAGE
VERBINDUNGSHAKEN



Sistema di aggancio tra elementi
 Components connector
 Systeme d'assemblage de socle
 Verbindungssystem zwischen Elemente

FINITURE IN METALLO
METAL FINISHES
FINITIONS MÉTAL
METALLAUSFÜHRUNGEN



Alluminio lucido
 Polished aluminum
 Aluminium brillant
 Poliert Aluminium



Alluminio opaco
 Matt aluminum
 Aluminium mat
 Aluminium matt

OPZIONE
OPTION
OPTION
OPZION

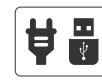

Su richiesta attacco per connessione elettrica e USB con sovrapprezzo
 Electrical connection and USB upon request with upcharge
 Sur demande connection électrique et USB avec surcoût
 Elektrische Verbindung und USB-Anschluss auf Anfrage gegen Aufpreis

RIVESTIMENTI CONSIGLIATI
RECOMMENDED COVERINGS
REVÊTEMENTS CONSEILLÉS
EMPFOHLENE BEZÜGE

CAT. START
 RINGO
 OPUS

CAT. A
 XTREME
 TAILOR
 ANGEL
 MEDLEY
 SAMAR
 AVON
 MAGNUM
 AUTUMN
 HANGO

CAT. B
 FAME
 MAIN LINE FLAX
 HESTAN
 SILVERTEX
 GEIKO

CAT. C
 SUPERB
 TREND
 KEN BI
 MIKONOS
 ANDROS

CAT. SUPER
 ORSETTO
 REMIX 3
 MYLLA
 TWISTED FLOWER
 DHARMA DIS.400
 DHARMA DIS.200
 DHARMA DIS.600
 DHARMA DIS.100
 DHARMA DIS.500
 DIVA DIS.01

CAT. EXTRA
 STEELCUT TRIO 3
 ARIANA
 OPERA
 ARCO
 CREDO
 TRIO
 BIT
 DIVA DIS.05
 DIVA DIS.21
 DIVA DIS.29

CAT. MAXI
 UNIFORM MÉLANGE
 HALLINGDAL 65
 DIVINA 3

CAT. TOP
 ARDA
 REGOS

CAT. SPECIAL
 GENTLE 2

CAT. LUX
 LUX 1
 LUX 2

CAT. IMPERIAL
 IMPERIAL 1
 IMPERIAL 2

**POLTRONE
ARMCHAIRS
FAUTEUILS
SESSELS**

COD. 5100N
ARMCHAIR

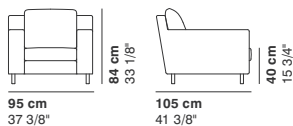

**DIVANI
SOFAS
CANAPÉS
SOFAS**

COD. 5102N
2 SEATER SOFA

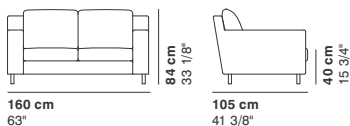

COD. 5103N
2 SEATER SOFA MAJOR

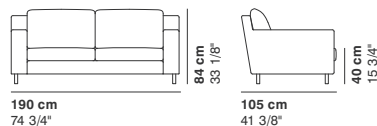

COD. 5104N
3 SEATER SOFA

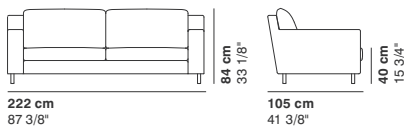

COD. 5105N
3 SEATER SOFA MAJOR

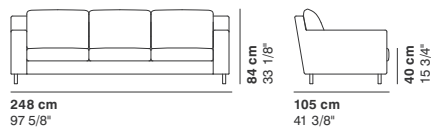

**POUF
OTTOMAN
POUF
HOCKER**

COD. 5118N
OTTOMAN 60

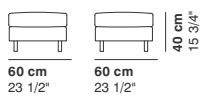

COD. 5119N
OTTOMAN 100

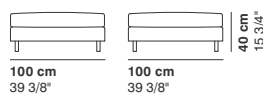

**COMPONIBILI
SYSTEM
CANAPÉS MODULAIRES
MODULAR SOFAS**

COD. 5106N
CORNER

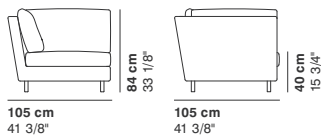

COD. 5107N
ELEMENT 70

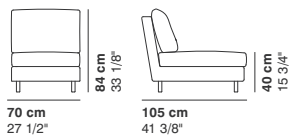

COD. 5108N
ELEMENT 86 RIGHT

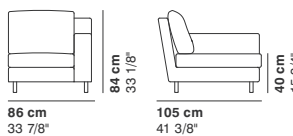

COD. 5109N
ELEMENT 86 LEFT

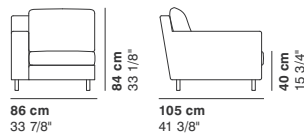

COD. 5110N
ELEMENT 144 RIGHT

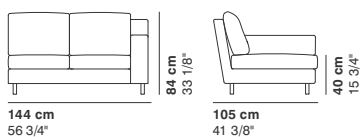

COD. 5111N
ELEMENT 144 LEFT

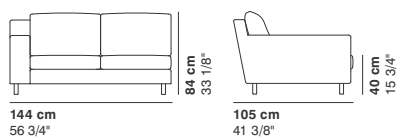

COD. 5112N
ELEMENT 206 RIGHT

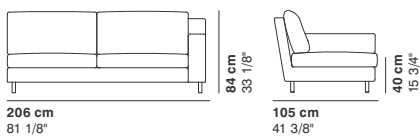

COD. 5113N
ELEMENT 206 LEFT

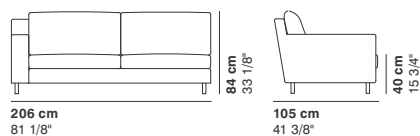

COD. 5114N
SMALL RIGHT DORMEUSE

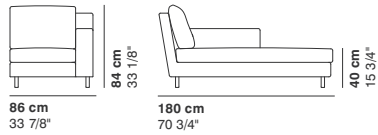

COD. 5115N
SMALL LEFT DORMEUSE

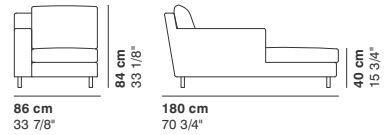

COD. 5116N
RIGHT BIG DORMEUSE

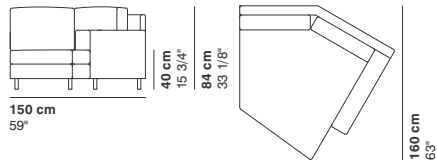

COD. 5116N
LEFT BIG DORMEUSE

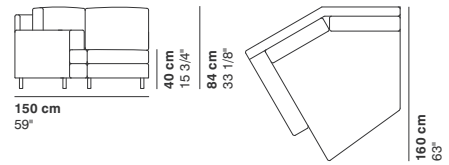

La Cividina s.r.l., al fine di migliorare le caratteristiche tecniche e qualitative della sua produzione, si riserva di apportare, anche senza preavviso, tutte le modifiche che si rendessero necessarie.

With a view to improving the technical characteristics and quality of its products la Cividina s.r.l. reserves the right to develop its products at anytime without notice.

A fin d'améliorer les caractéristiques de sa production, La Cividina s.r.l. se réserve d'apporter, même sans préavis, toutes les modifications qui se rendent nécessaires.

Zur Verbesserung, der technischen und qualitativen Merkmale, behält sich La Cividina s.r.l. vor, alle notwendig erscheinenden Produktionsänderungen, auch ohne Vorankündigung durchzuführen.

LA CIVIDINA S.R.L.

HEADQUARTERS / PRODUCTION

Via Spilimbergo 162
33035 Martignacco
Udine Italy
T +39 0432 677433
F +39 0432 677480
info@lacividina.com
lacividina.com

ISO 9001



SHOWROOM MARTIGNACCO

Via Lungolavia 1
33035 Martignacco
Udine Italy
T +39 0432 677433

SHOWROOM MILANO

Palazzo Borromeo
Via Manzoni 41
20121 Milano
Italy
T +39 345 8350810