

LC

Collection

Bernard
Couchette
Phar Lap
Swale

+ 4

laCividina

Collection

Bernard

ARMCHAIR / SMALL ARMCHAIR / SOFA / DORMEUSE
/ OTTOMAN / BENCH / SYSTEM / COFFEE TABLE

Couchette

ARMCHAIR / SOFA / SYSTEM

Phar Lap

ARMCHAIR

Swale

ARMCHAIR

BERNARD cod. 1120
Armchair cornel small /
BERNARD cod. 1141
Coffee table

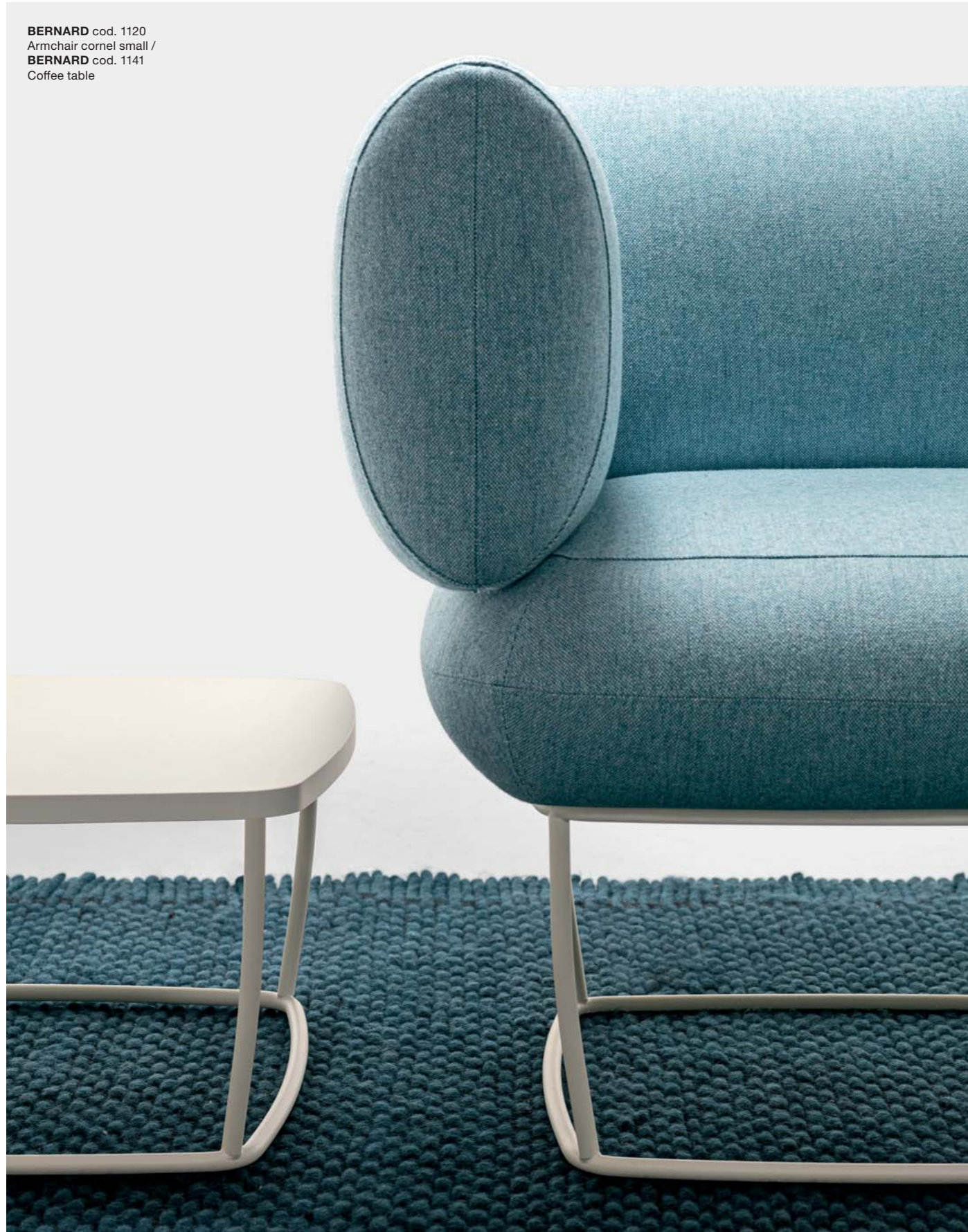

Bernard

Family

Armchair / Small armchair / Sofa
/ Dormeuse / Ottoman / Bench
/ System / Coffee table

Designer

Nina Mair / 2020

Link

www.read-mo.re/bernard

IT Bernard è una collezione completa e versatile, adatta agli ambienti residenziali e del contract. Il nucleo originario è costituito dalla sofisticata poltroncina, che si distingue per la doppia direzione della seduta, ottenuta grazie alla progettazione di moduli identici per schienale e bracciolo, che possono liberamente variare la loro funzione. Accanto alla poltroncina: il divano da due e tre posti, il pouf, la lounge chair e due tavolini caratterizzati dalla stessa struttura leggera in metallo della seduta. Grazie alla pluralità di elementi disponibili, Bernard permette di creare composizioni originali e sempre confortevoli.

EN

Bernard is a complete and versatile collection, suitable in both residential and contract. The original core is represented by a sophisticated small armchair, which stands out for the double seat direction, obtained thanks to the design of identical modules for the backrest and armrest, which can freely vary their function. Beside the small armchair: the two and three seater sofa, ottomans, lounge chair and two tables characterized by the same lightweight metal seat structure. Thanks to the plurality of available elements, Bernard allows to create original and always comfortable compositions.

FR

Bernard est une collection complète et polyvalente, adaptée à la fois pour les aménagements résidentiels et collectifs. La base du système se compose d'une assise d'angle deux directions encadrée par deux dossiers identiques qui servent également d'accoudoirs en fonction de la posture d'assise sur le siège. En complément de ce siège: on trouve des canapés deux et trois places, une dormeuse, un pouf, un fauteuil et deux tables basses qui se caractérisent tous par le même piétement en une fine structure métallique. Grâce à la diversité des éléments disponibles, Bernard vous permet de créer des compositions simples ou modulaires à la fois originales et confortables.

DE

Bernard ist eine vollständige und vielseitige Kollektion, die sich für den Wohn- und Objektbereich eignet. Der ursprüngliche Kern besteht aus dem raffinierten Sessel, der sich durch die zweifache Richtung des Sitzes auszeichnet. Die Rücken- und Armlehne sind identische Module deren Funktion und Position frei variiert werden kann. Zusätzlich zum Sessel: das Zwei- und Dreisitzer-Sofa, der Hocker, der Loungesessel und zwei Tische, die sich durch die gleiche Leichtmetallstruktur wie der Sitz auszeichnen. Dank der Vielzahl der verfügbaren Elemente können Sie mit Bernard originelle und stets komfortable Kompositionen erstellen.

BERNARD cod. 1120
Armchair corner small /
BERNARD cod. 1121
Armchair central small /
ACCURSIO
cod. 9030 / 9036 / 9037
Coffee table





BERNARD cod. 1120
 Armchair corner small /
BERNARD cod. 1121
 Armchair central small /
BERNARD cod. 1141
 Coffee table /
TURI TURI cod. 8771_D35
 Coffee table /
MIL cod. 9097
 Coffee table /
SCANCARO
 cod. 8830 / 8831 / 8835
 Coffee table

BERNARD cod. 1133
3 seater sofa /
BERNARD cod. 1134
Dormeuse /
BERNARD cod. 1140
Coffee table /
ACCURSIO cod. 9030
Coffee table /
U cod. 1100
Coffee table





BERNARD cod. 1130
Armchair /
BERNARD cod. 1140
Coffee table

BERNARD cod. 1130
Armchair

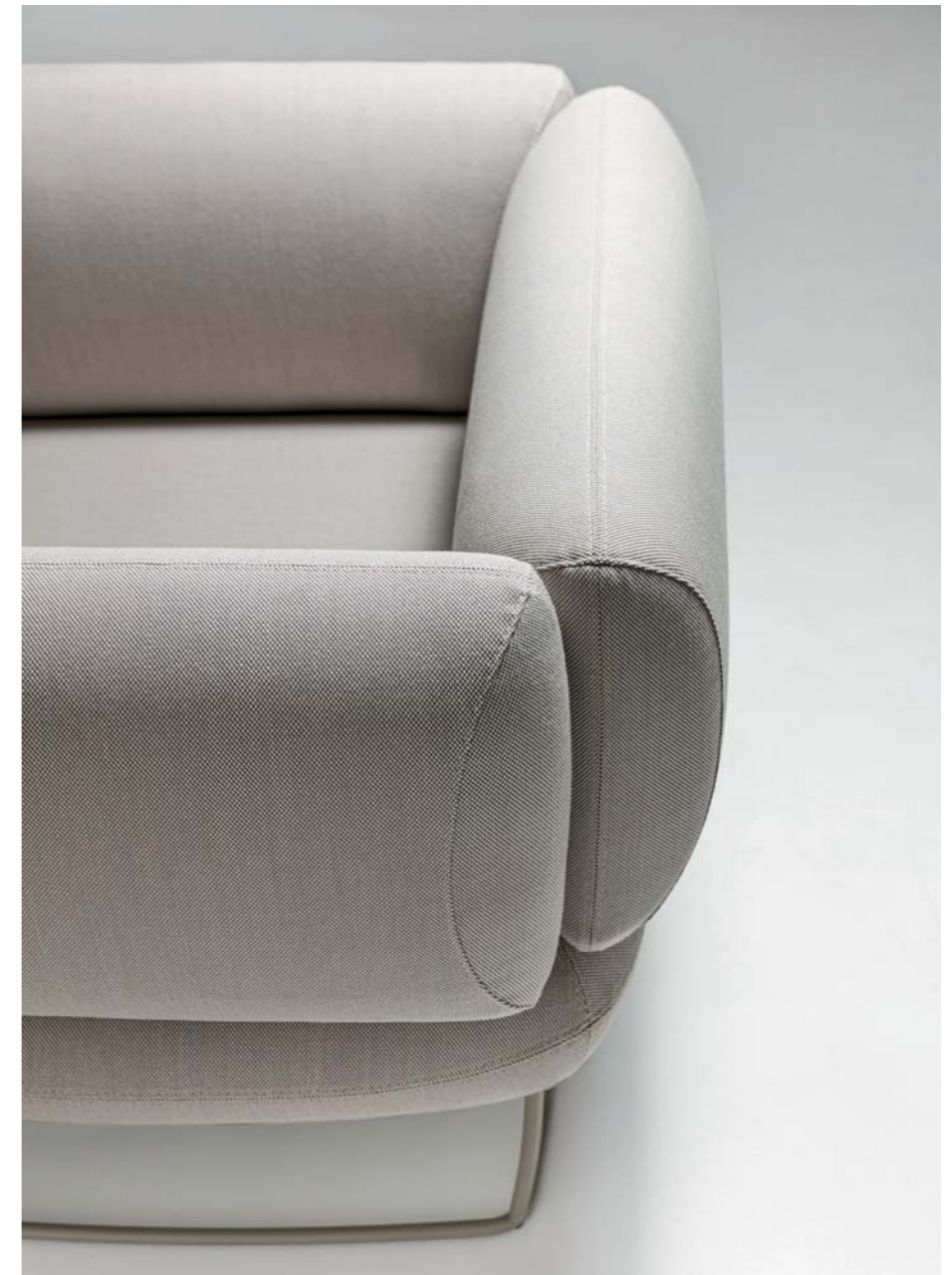

BERNARD 1131
Armchair central /
BERNARD cod. 1135
Ottoman /
BERNARD cod. 1140 / 1141
Coffee table /
SCANCARÒ cod. 8830
Coffee table



BERNARD cod. 1124 / 1125 / 1135
Ottoman /
BERNARD cod. 1140 / 1141
Coffee table



BERNARD cod. 1130
Armchair /
BERNARD cod. 1140 / 1141
Coffee table



BERNARD cod. 1122
Armchair small /
BERNARD cod. 1124
Ottoman /
BERNARD cod. 1140
Coffee table /
ACCURSIO cod. 9030
Coffee table



BERNARD cod. 1133
3 seater sofa



Dati tecnici - Technical data - Données techniques - Technische Angaben

Armchair

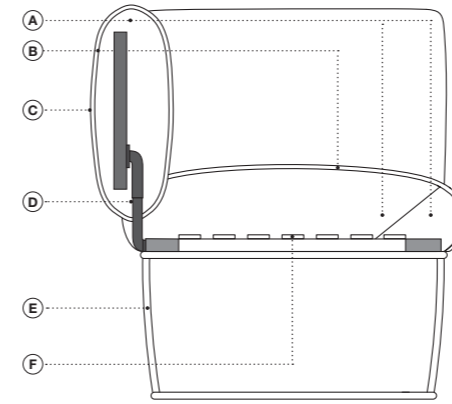

■ Legno massiccio di faggio
■ Multistrato di faggio
A. Poliuretano espanso ignifugo a quote differenziate
B. Fibra di poliestere
C. Rivestimento
D. Acciaio
E. Acciaio verniciato
F. Cinghie elastiche ad alta densità
G. MDF / Rovere spazzolato / Marmo

■ Solid beech
■ Multilayered beech
A. Flame-retardant undeformable polyurethane foam of different densities
B. Polyester fibers
C. Upholstery
D. Steel
E. Lacquered steel
F. High density elastic straps
G. MDF / Brushed oak / Marble

Coffee table

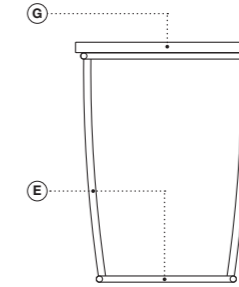

■ Bois de hêtre massif
■ Multiplis de hêtre
A. Mousse polyuréthane expansé ignifuge indéformable à épaisseurs différenciées
B. Fibre de polyester
C. Revêtement
D. Acier
E. Acier laqué
F. Sangles élastiques
G. MDF / Chêne brossé / Marbre

■ Massivholz aus Buche
■ Buchenschichtholz
A. Feuerfester formbeständige Polyurethanschaum in unterschiedlicher Dichte
B. Polyester
C. Bezug
D. Stahl
E. Lackierter Stahl
F. Elastischen Gurtbändern
G. MDF / Eichenholz gebürstet / Marmor

Caratteristiche - Features - Caractéristiques - Eigenheiten

· Telaio rinforzato per uso aree pubbliche
· Poliuretano espanso ignifugo
· Poliuretano espanso indeformabile a quote differenziate ad alta densità
· Cuciture rinforzate con supporto in fibra di carbonio
· Basi personalizzabili con colore su richiesta del cliente

· Reinforced frame for public area use
· Flame-retardant polyurethane foam
· Undeformable polyurethane foam of different densities
· Reinforced stitching with carbon fiber support
· Bases customizable with other colors on customer's request

· Structure renforcée pour une utilisation en espace public
· Mousse polyuréthane expansé ignifuge
· Mousse polyuréthane expansé indéformable à épaisseurs différenciées
· Coutures renforcées de fibre de carbone
· Piètements disponibles en autres finitions sur demande

· Verstärkte Holzstruktur für Nutzung bei öffentlichem Bereich
· Feuerfester Polyurethanschaum
· Formbeständige Polyurethanschaum in unterschiedlicher Dichte
· Verstärkte Säume mit Stütz aus Kohlefaser
· Gestell in Kundenfarben auf Anfrage verfügbar

Coordinati - Matching items - Produits assortis - Abgestimmte Produkte



ACCURSIO



UP

Finitura base · Base finish · Finition de piètement · Gestell Ausführung



Avorio
Ivory
Elfenbein



Fango
Mud
Boue
Schlamm



Prugna
Plum
Prune
Pflaume



Nero pece
Pitch black
Poix noir
Pech Schwarz

Finiture piano tavolo · Table top finishes · Finitions de plateau de table · Tischplatten Ausführungen



Rovere spazzolato naturale
Natural brushed oak
Chêne brossé naturel
Eichenholz Natural gebürstet



Rovere spazzolato grafite
Graphite brushed oak
Chêne brossé graphite
Eichenholz Graphit gebürstet



Rovere spazzolato bianco
White brushed oak
Chêne brossé blanc
Eichenholz Weiß gebürstet



MDF bianco (RAL 9016)
MDF white (RAL 9016)
MDF blanc (RAL 9016)
MDF Weiß (RAL 9016)



MDF nero (RAL 9005)
MDF black (RAL 9005)
MDF noir (RAL 9005)
MDF Schwarz (RAL 9005)



Marmo Nero Marquina
Black Marquina marble
Marbre Noir Marquina
Marquina Schwarz Marmor



Marmo di Carrara
Carrara marble
Marbre Carrara
Carrara Marmor



Marmo Calacatta
Calacatta marble
Marbre Calacatta
Calacatta Marmor

cod. 1120 / armchair corner small

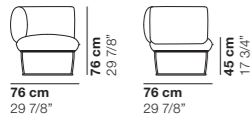

cod. 1121 / armchair central small

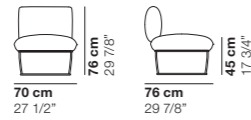

cod. 1122 / armchair small

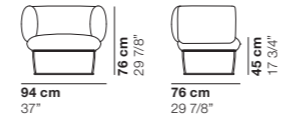

cod. 1124 / small ottoman

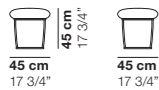

cod. 1125 / medium ottoman

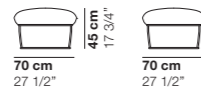

cod. 1130 / armchair

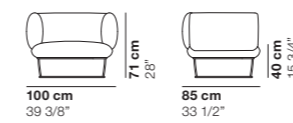

cod. 1131 / armchair central

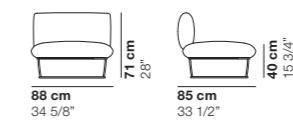

cod. 1132 / 2 seater sofa

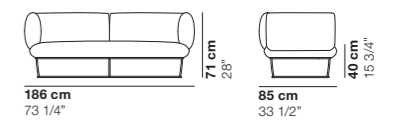

cod. 1133 / 3 seater sofa

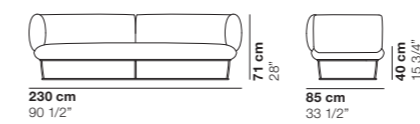

cod. 1134 / dormeuse

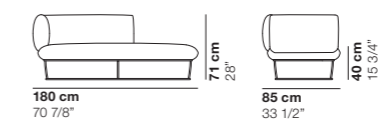

cod. 1135 / large ottoman

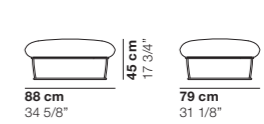

cod. 1136 / bench



cod. 1140 / coffee table small

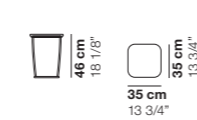

cod. 1141 / coffee table medium

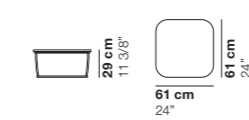



COUCHETTE cod. 1208
 Right armrest /
COUCHETTE cod. 1198
 Left closed element 180 15° R110 /
COUCHETTE cod. 1199
 Right closed element 180 15° R110 /
COUCHETTE cod. 1183
 Open element 90° R110 /
COUCHETTE cod. 1280
 Central coffee table /
SCANCARÒ cod. 8830 /8831
 Coffee table

Couchette

Family	Armchair / Sofa / System
Designer	LucidiPevere / 2020
Link	www.read-mo.re/couchette

IT Ispirato alle omonime cuccette del treno, Couchette è l'innovativo sistema modulare di imbottiti che sintetizza l'idea di una catena di ambienti uniti e isolati tra loro. I 38 elementi della collezione permettono grande libertà compositiva, fino a creare confortevoli stanze di diverse dimensioni. Pannelli imbottiti rimovibili possono essere posizionati in qualsiasi punto della seduta senza perdita di spazio, mentre gli accessori, come tavolini, connessioni elettriche-USB e ganci appendiabito, trasformano Couchette in spazi di lavoro temporanei estremamente silenziosi.

EN Inspired by the homonymous train bunks, Couchette is the innovative modular system in upholstered furniture that summarizes the idea of a chain of united and isolated environments. The 38 elements allow great composition freedom, up to create comfortable rooms in different sizes. Removable padded panels can be positioned anywhere in the seat without loss of space, while accessories, such as tables, USB-electrical connections and coat hooks, turn Couchette into extremely quiet temporary workspaces.

FR Inspiré des banquettes de trains, Couchette est un système modulaire innovant composé d'éléments rembourrés qui s'assemblent pour donner l'idée d'une chaîne dans l'espace. Les 38 éléments de la collection permettent de grandes libertés dans les aménagements, permettant ainsi de créer des espaces de différentes tailles et différentes formes. Des panneaux de séparations rembourrés amovibles peuvent être positionnés pour structurer les compositions sans pertes d'espaces, tandis que les accessoires, tels que tablettes, connexions électriques, patères, transforment les banquettes Couchette en espaces de travail temporaires à la fois confortables et silencieux.

DE Couchette wurde von den gleichnamigen Zugkojen inspiriert. Es handelt sich um ein innovatives modulares System von Polstermöbeln, das unendlich erweitert und nach Belieben abgetrennt werden kann. Die 38 Elemente der Kollektion ermöglichen eine große Kompositionsfreiheit und schaffen komfortable Räume unterschiedlicher Größe. Abnehmbare gepolsterte Paneele können überall im Sitz ohne Platzverlust positioniert werden, während Zubehör wie Tische, USB-elektrische Anschlüsse und Kleiderhaken Couchette in extrem leise temporäre Arbeitsbereiche verwandeln.

COUCHETTE cod. 1208
Right armrest /
COUCHETTE cod. 1198
Left closed element 180 15° R110 /
COUCHETTE cod. 1199
Right closed element 180 15° R110 /
COUCHETTE cod. 1183
Open element 90° R110
COUCHETTE cod. 1174
element 150





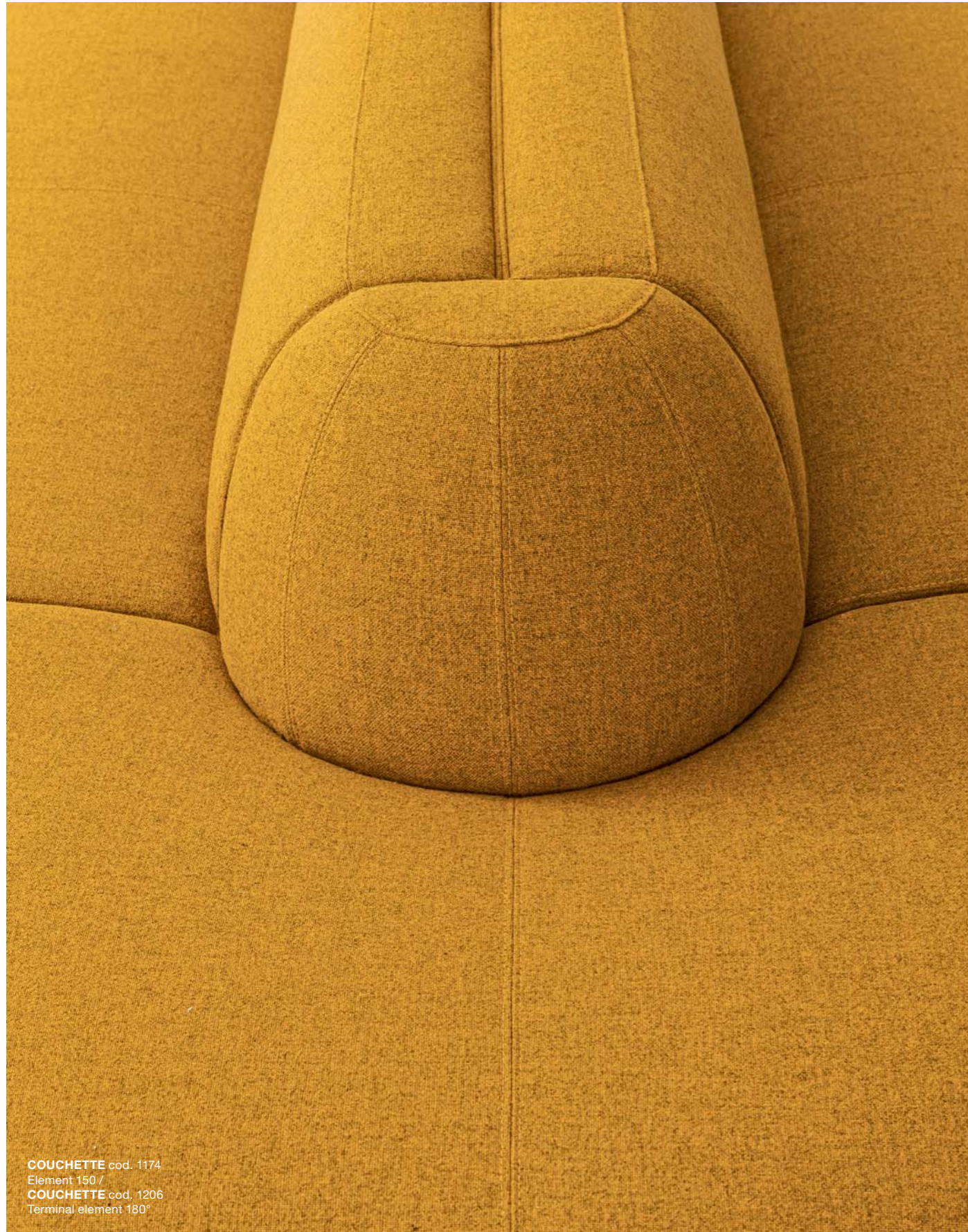

COUCHETTE cod. 1174
Element 150 /
COUCHETTE cod. 1206
Terminal element 180°



COUCHETTE cod. 1174
Element 150 /
COUCHETTE cod. 1206
Terminal element 180°

COUCHETTE

ARMCHAIR / SOFA / SYSTEM



COUCHETTE cod. 1174
 Element 150 /
COUCHETTE cod. 1206
 Terminal element 180° /
ACCURSIO cod. 9036
 Coffee table /
MIL cod. 9097
 Coffee table

COUCHETTE cod. 1172
3 seater sofa

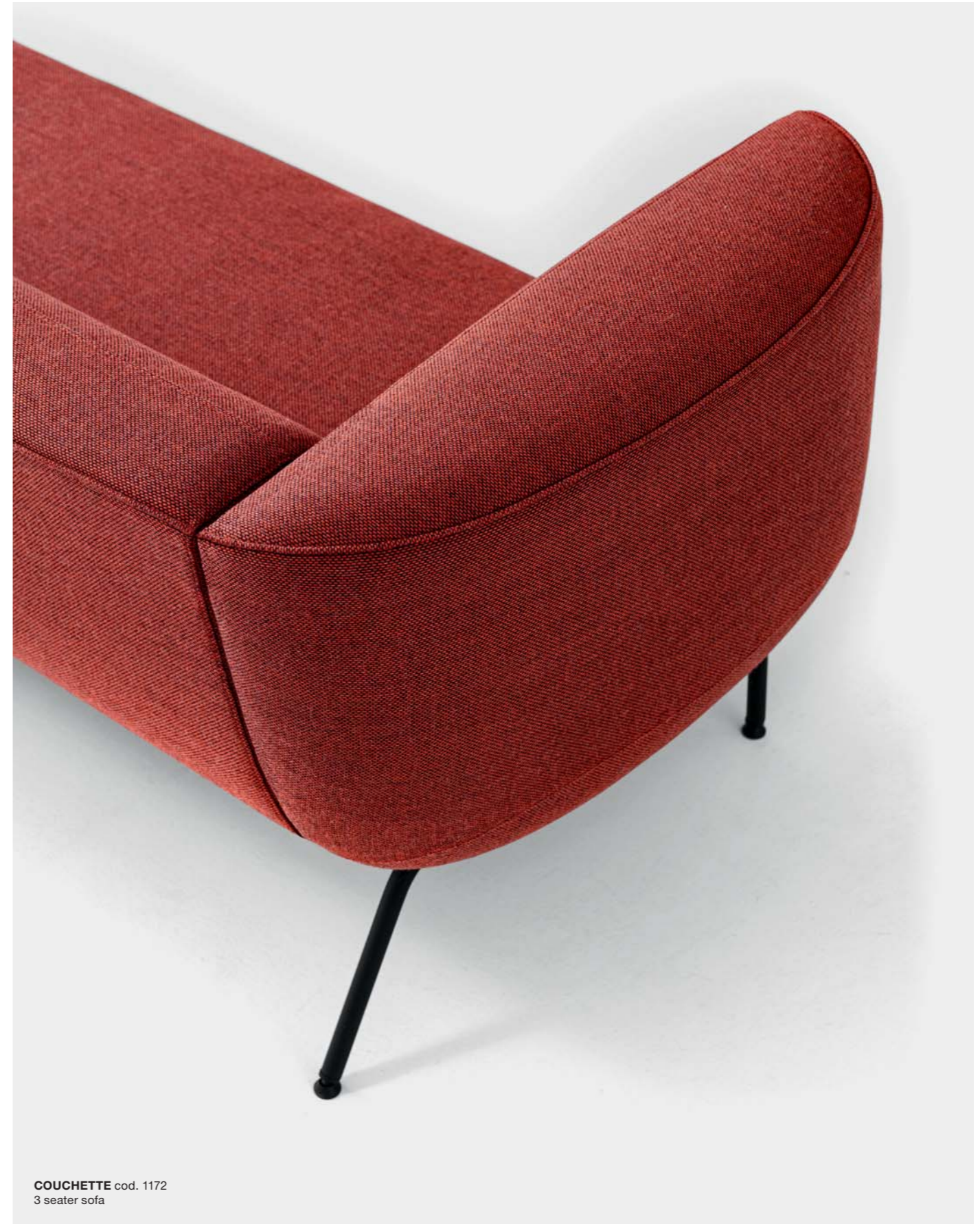

COUCHETTE cod. 1172
3 seater sofa

COUCHETTE cod. 1172
3 seater sofa /
BERNARD cod. 1140 / 1141
Coffee table /
SCANCARÒ cod.8832
Coffee table







COUCHETTE cod. 1207
Left armrest /
COUCHETTE cod. 1199
Right closed element 180 15° R110 /
COUCHETTE cod. 1198
Left closed element 180 15° R110 /
COUCHETTE cod. 1208
Right armrest /
SCANCARÒ cod. 8830 / 8831 / 8835
Coffee table



COUCHETTE cod. 1280
Central coffee table



Dati tecnici · Technical data · Données techniques · Technische Angaben

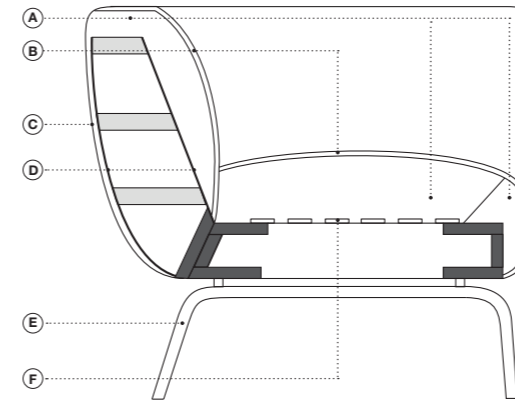

- Legno massiccio di abete
- Multistrato di faggio
- A.** Poliuretano espanso ignifugo a quote differenziate
- B.** Fibra di poliestere
- C.** Rivestimento
- D.** Pannelli di masonite
- E.** Acciaio verniciato
- F.** Cinghie elastiche ad alta densità

- Solid fir
- Multilayered beech
- A.** Flame-retardant undeformable polyurethane foam of different densities
- B.** Polyester fibers
- C.** Upholstery
- D.** Masonite panels
- E.** Lacquered steel
- F.** High density elastic straps

- Bois de sapin massif
- Multiplis de hêtre
- A.** Mousse polyuréthane expansé ignifuge indéformable à épaisseurs différenciées
- B.** Fibre de polyester
- C.** Revêtement
- D.** Panneau de particules
- E.** Acier laqué
- F.** Sangles élastiques

- Massiveholz aus Tanne
- Buchenschichtholz
- A.** Feuerfester formbeständige Polyurethanschaum in unterschiedlicher Dichte
- B.** Polyester
- C.** Bezug
- D.** Holzfaserplatte
- E.** Lackierter Stahl
- F.** Elastischen Gurtbändern

Caratteristiche · Features · Caractéristiques · Eigenheiten

- Telaio rinforzato per uso aree pubbliche
- Poliuretano espanso ignifugo
- Poliuretano espanso indeformabile a quote differenziate ad alta densità
- Cuciture rinforzate con supporto in fibra di carbonio
- Basi personalizzabili con colore su richiesta del cliente

- Reinforced frame for public area use
- Flame-retardant polyurethane foam
- Undeformable polyurethane foam of different densities
- Reinforced stitching with carbon fiber support
- Bases customizable with other colors on customer's request

- Structure renforcée pour une utilisation en espace public
- Mousse polyuréthane expansé ignifuge
- Mousse polyuréthane expansé indéformable à épaisseurs différenciées
- Coutures renforcées de fibre de carbone
- Piètements disponibles en autres finitions sur demande

- Verstärkte Holzstruktur für Nutzung bei öffentlichem Bereich
- Feuerfester Polyurethanschaum
- Formbeständige Polyurethanschaum in unterschiedlicher Dichte
- Verstärkte Säume mit Stütz aus Kohlefaser
- Gestell in Kundenfarben auf Anfrage verfügbar

Coordinati · Matching items · Produits assortis · Abgestimmte Produkte



ACCURSIO



MIL



SCANCARÒ

Finitura base · Base finish · Finition de piètement · Gestell Ausführung



Nero pece
Pitch black
Poix noir
Pech Schwarz



MDF bianco (RAL 9016)
MDF white (RAL 9016)
MDF blanc (RAL 9016)
MDF Weiß (RAL 9016)



MDF nero (RAL 9005)
MDF black (RAL 9005)
MDF noir (RAL 9005)
MDF Schwarz (RAL 9005)

Finiture tavolo · Table finishes · Finitions de table · Tischausführungen

cod. 1170 / armchair

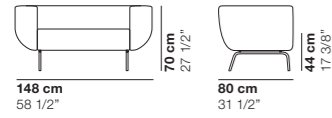

cod. 1171 / 2 seater sofa

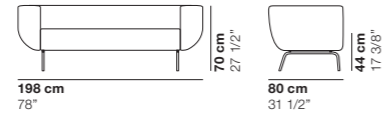

cod. 1172 / 3 seater sofa

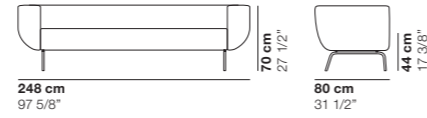

cod. 1188 / closed element 45° R190

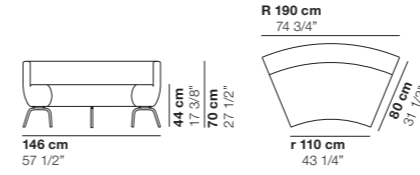

cod. 1189 / open element 45° R190

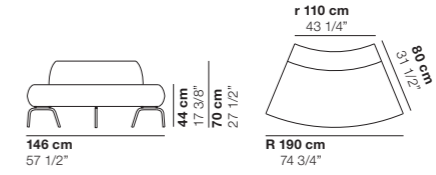

cod. 1173 / element 100

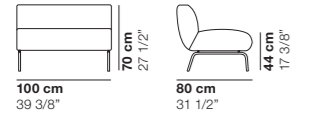

cod. 1174 / element 150

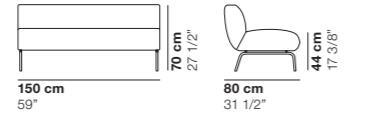

cod. 1175 / element 200

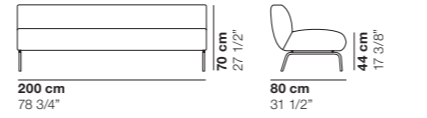

cod. 1190 / closed element 30° R270

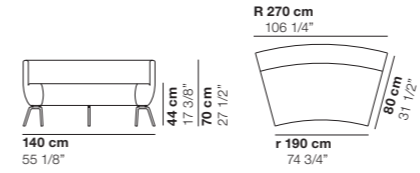

cod. 1191 / open element 30° R270

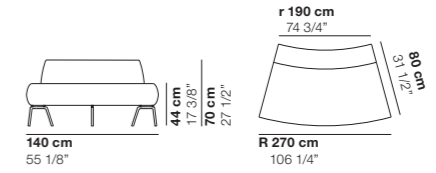

cod. 1176 / left element 124

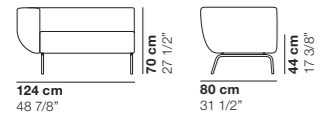

cod. 1177 / right element 124

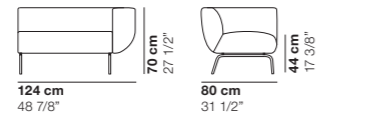

cod. 1178 / left element 174

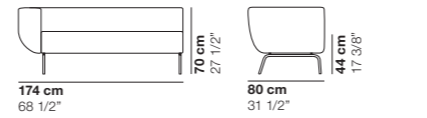

cod. 1192 / closed element 45° R270

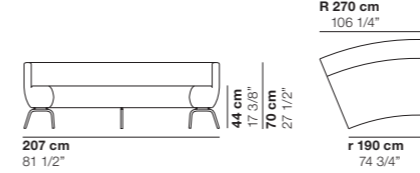

cod. 1193 / open element 45° R270

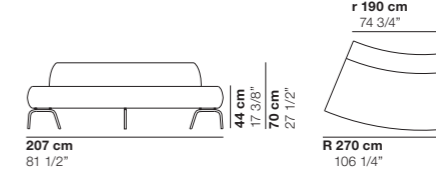

cod. 1179 / right element 174

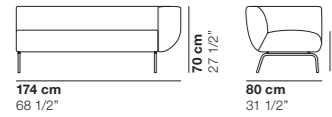

cod. 1180 / closed element 45° R110

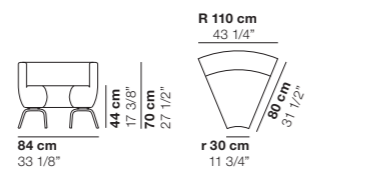

cod. 1181 / open element 45° R110

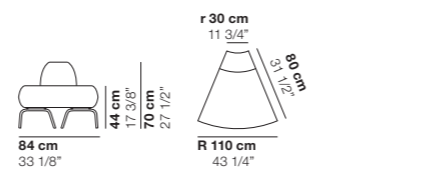

cod. 1194 / left closed element 130 15° R110

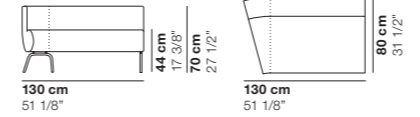

cod. 1195 / right closed element 130 15° R110

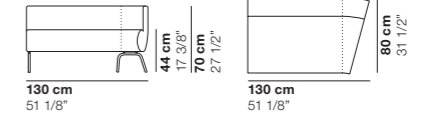

cod. 1182 / closed element 90° R110

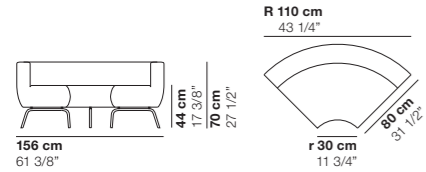

cod. 1183 / open element 90° R110

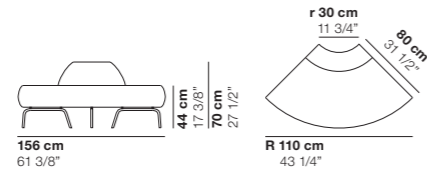

cod. 1184 / closed element 60° R110

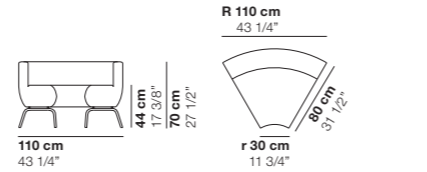

cod. 1196 / left open element 130 15° R110

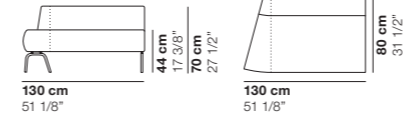

cod. 1197 / right open element 130 15° R110

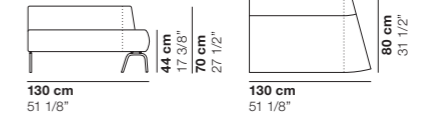

cod. 1185 / open element 60° R110

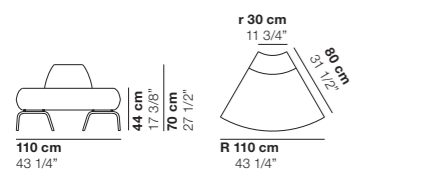

cod. 1186 / closed element 30° R190

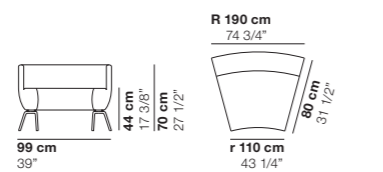

cod. 1187 / open element 30° R190

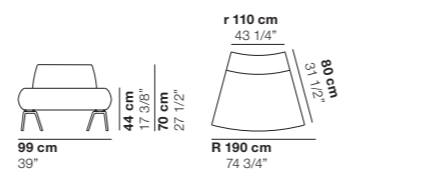

cod. 1198 / left closed element 180 15° R110

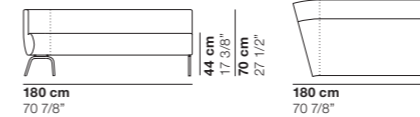

cod. 1199 / right closed element 180 15° R110

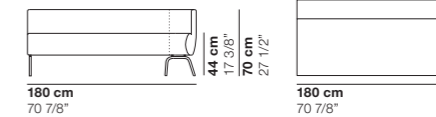

cod. 1200 / left open element 180 15° R110

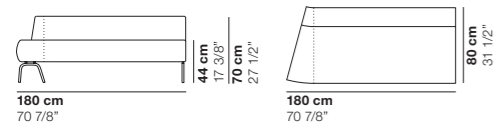

cod. 1201 / right open element 180 15° R110

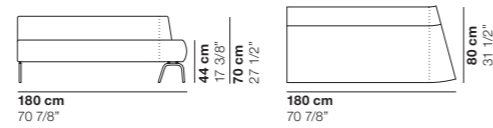

cod. 1202 / open element 160 15° R110

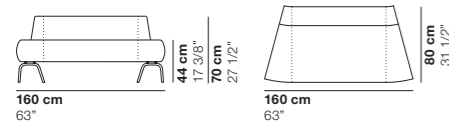

cod. 1203 / closed element 160 15° R110

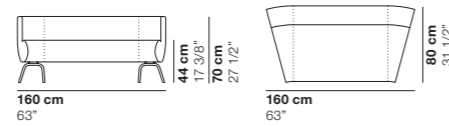

cod. 1204 / open element 210 15° R110

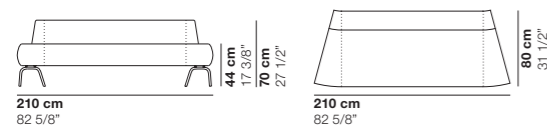

cod. 1205 / closed element 210 15° R110

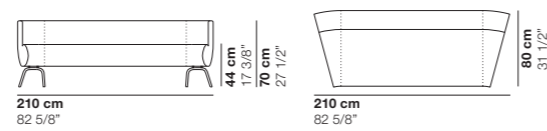

cod. 1206 / terminal element 180°

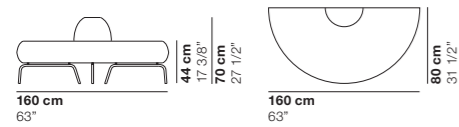

cod. 1207 / left armrest

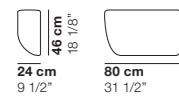

cod. 1208 / right armrest

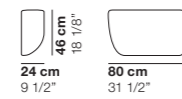

cod. 1209S / single side panel h. 115

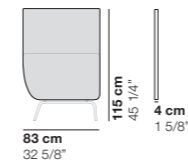

cod. 1209D / double side panel h. 115

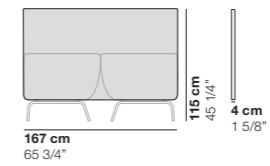

cod. 1210S / single side panel h. 135

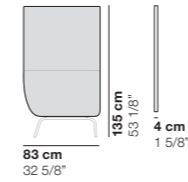

cod. 1210D / double side panel h. 135

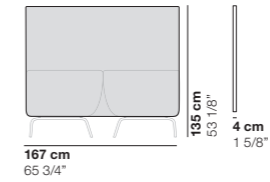

cod. 1211 / back panel 100 h. 115

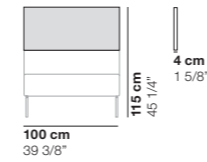

cod. 1212 / back panel 100 h. 135

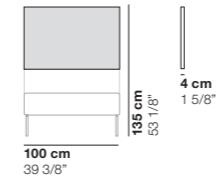

cod. 1213 / back panel 150 h. 115

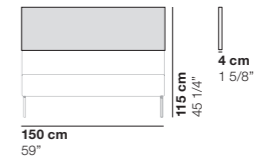

cod. 1214 / back panel 150 h. 135

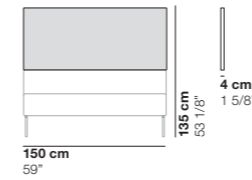

cod. 1215 / back panel 200 h. 115

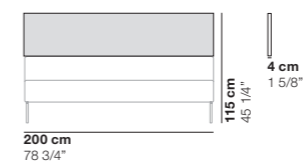

cod. 1216 / back panel 200 h. 135

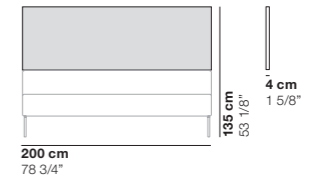

cod. 1280 / central coffee table

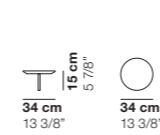

cod. 1281 / central coffee table with wireless recharge

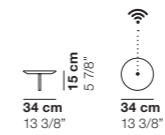

cod. 1282 / wall coffee table

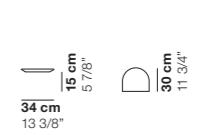

cod. 1283 / USB-socket



cod. 1284 / hanger



PHAR LAP cod. 1160
Lounge chair



Phar Lap

Family

Armchair

Designer

Gordon Guillaumier / 2020

Link

www.read-mo.re/pharlap

IT Phar Lap è la *lounge chair* pensata per portare comfort e protezione all'interno degli spazi collettivi, grazie a una struttura slanciata e ispirata al design degli anni Settanta. Lo schienale sagomato si allunga verso l'alto per consentire una postura distinta e, al contempo, schermare la seduta dall'ambiente circostante. Elemento distintivo della seduta è l'elegante struttura a vista, che in questo progetto è portata all'estremo con un risultato di solidità e raffinata geometria.

EN

Phar Lap is the lounge chair designed to bring comfort and protection to collective spaces, thanks to a slender structure inspired by the design of the seventies. The shaped backrest extends upwards to allow a distinct posture and, at the same time, shield the seat from the surrounding environment. The distinctive element of the seat is the elegant visible structure, which in this project is taken to the extreme with a result of solidity and refined geometry.

FR

Phar Lap est un siège haut dossier conçu pour les espaces collectifs où il apporte à la fois confort et intimité grâce à sa structure élancée inspirée du design des années 70. Avec la forme du dossier qui s'étend vers le haut le siège Phar Lap isole l'utilisateur de son environnement. L'élément distinctif du siège Phar Lap est l'élégante structure apparente, qui dans ce projet est poussée à l'extrême donnant à la fois un effet de solidité et de géométrie raffinée.

DE

Phar Lap ist der Loungesessel der vom Design der siebziger Jahre inspiriert wurde. Dank seiner schlanken Struktur bietet er Komfort und Schutz in kollektiven Räumen. Die geformte Rückenlehne erstreckt sich nach oben, um eine bestimmte Haltung zu ermöglichen und gleichzeitig den Sitz vor der Umgebung zu schützen. Das charakteristische Element des Sitzes ist die elegante sichtbare Struktur, die in diesem Projekt durch Solidität und raffinierte Geometrie auf die Spitze getrieben wird.

PHAR LAP

ARMCHAIR

PHAR LAP cod. 1160
Lounge chair /
TURI TURI
cod. 8770_D30 / 8772_D40
Coffee table /
SCANCARÒ cod. 8830
Coffee table



PHAR LAP

PHAR LAP cod. 1160
Lounge chair



ARMCHAIR

PHAR LAP cod. 1160
Lounge chair



PHAR LAP

PHAR LAP cod. 1160
Lounge chair /
ACCURSIO cod. 9043
Coffee table /
SCANCARÒ cod. 8832
Coffee table /
MIL cod. 9097
Coffee table



ARMCHAIR

PHAR LAP cod. 1160
Lounge chair /
SCANCARÒ
cod. 8830 / 8831 / 8832
Coffee table



PHAR LAP

ARMCHAIR

PHAR LAP cod. 1160
Lounge chair /
TURI TURI cod. 8771_D35
Coffee table /
SCANCARÒ cod. 8831
Coffee table



PHAR LAP cod. 1160
Lounge chair



PHAR LAP cod. 1160
Lounge chair

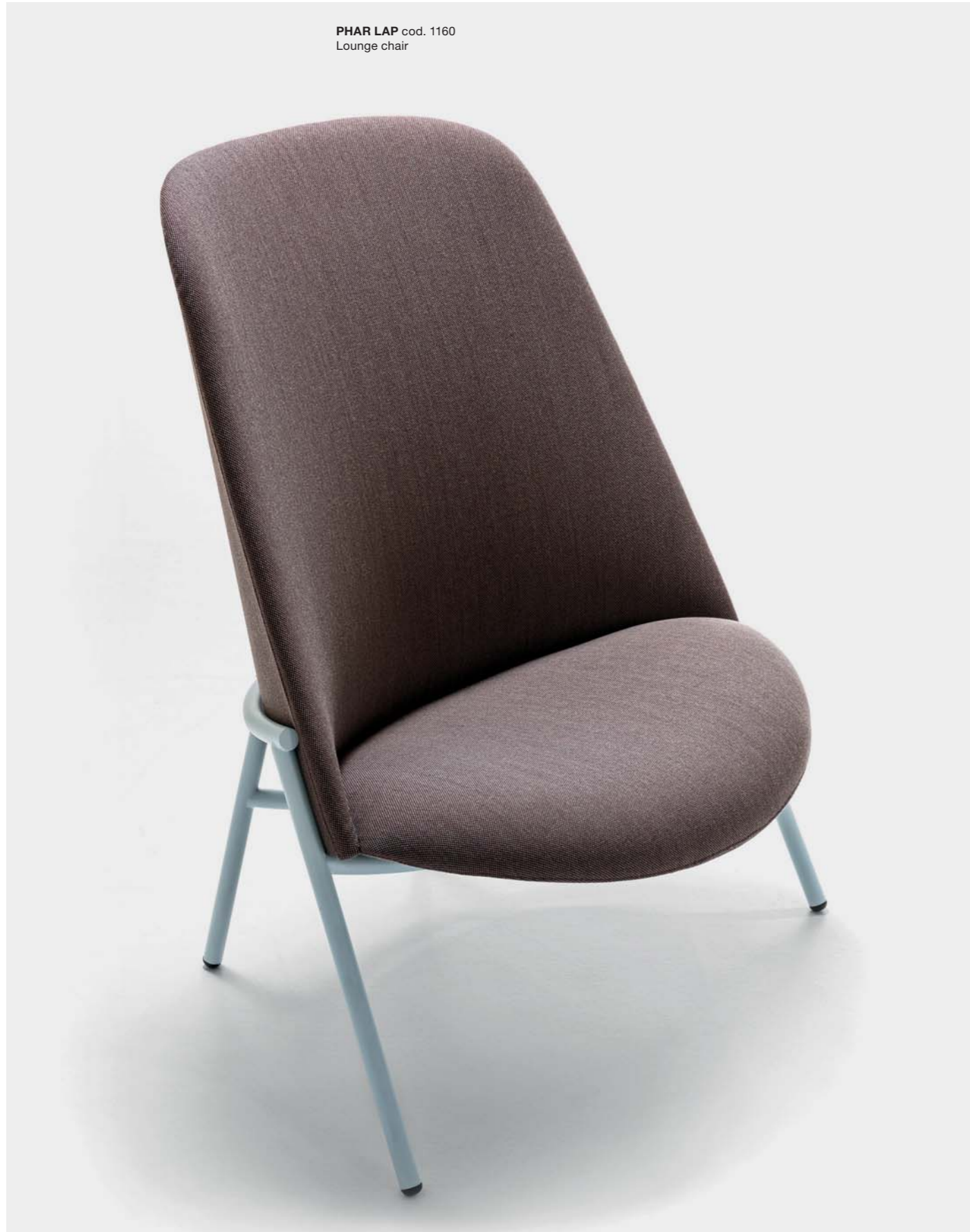

Dati tecnici - Technical data - Données techniques - Technische Angaben

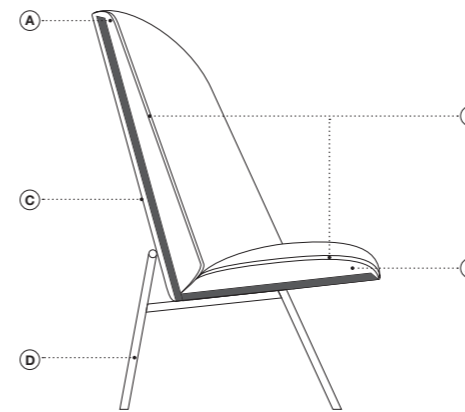

- | | |
|--|--|
| <ul style="list-style-type: none"> ■ Legno multistrato di faggio A. Poliuretano espanso ignifugo a quote differenziate B. Fibra di poliestere C. Rivestimento D. Acciaio verniciato | <ul style="list-style-type: none"> ■ Multilayered beech A. Flame-retardant undeformable polyurethane foam of different densities B. Polyester fibers C. Upholstery D. Lacquered steel |
|--|--|

- | | |
|---|---|
| <ul style="list-style-type: none"> ■ Multiplis de hêtre A. Mousse polyuréthane expansé ignifuge indéformable à épaisseurs différenciées B. Fibre de polyester C. Revêtement D. Acier laqué | <ul style="list-style-type: none"> ■ Buchenschichtholz A. Feuerfester formbeständige Polyurethanschaum in unterschiedlicher Dichte B. Polyester C. Bezug D. Lackierter Stahl |
|---|---|

Caratteristiche - Features - Caractéristiques - Eigenheiten

- | | | | |
|---|--|---|---|
| <ul style="list-style-type: none"> · Telaio rinforzato per uso aree pubbliche · Poliuretano espanso ignifugo · Poliuretano espanso indeformabile a quote differenziate ad alta densità · Cuciture rinforzate con supporto in fibra di carbonio · Basi personalizzabili con colore su richiesta del cliente | <ul style="list-style-type: none"> · Reinforced frame for public area use · Flame-retardant polyurethane foam · Undeformable polyurethane foam of different densities · Reinforced stitching with carbon fiber support · Bases customizable with other colors on customer's request | <ul style="list-style-type: none"> · Structure renforcée pour une utilisation en espace public · Mousse polyuréthane expansé ignifuge · Mousse polyuréthane expansé indéformable à épaisseurs différenciées · Coutures renforcées de fibre de carbone · Piètements disponibles en autres finitions sur demande | <ul style="list-style-type: none"> · Verstärkte Holzstruktur für Nutzung bei öffentlichem Bereich · Feuerfester Polyurethanschaum · Formbeständige Polyurethanschaum in unterschiedlicher Dichte · Verstärkte Säume mit Stütz aus Kohlefaser · Gestell in Kundenfarben auf Anfrage verfügbar |
|---|--|---|---|

Coordinati - Matching items - Produits assortis - Abgestimmte Produkte



ACCURSIO



TURI TURI



SCANCARÒ

Finitura base - Base finish - Finition de piètement - Gestell Ausführung



Avorio
Ivory
Ivoire
Elfenbein



Fango
Mud
Boue
Schlamm



Prugna
Plum
Prune
Pflaume



Nero pece
Pitch black
Poix noir
Pech Schwarz

cod. 1160 / lounge chair

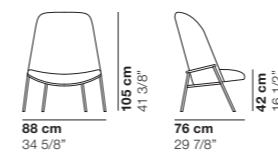



SWALE cod. 1151
Low armchair with legs

Swale

Family	Armchair
Designer	Gordon Guillaumier / 2020
Link	www.read-mo.re/swale

IT Grazie a una struttura abbondante e generosa, la poltrona Swale evoca rilassati scenari di conversazione per gli ambienti residenziali e contract. Il comfort della seduta è dato dalle sue forme ampie e avvolgenti, sapientemente riprodotte negli elementi di sedile e schienale. Nella sua versione con poggiatesta, Swale rappresenta una raffinata seduta da lettura; lo schienale basso, invece, ne permette un utilizzo efficace negli ambienti del contract, dove Swale porta le migliori caratteristiche di un imbottito domestico.

EN Thanks to an abundant and generous structure, the Swale armchair evokes relaxed conversation scenarios for residential and contract environments. The comfort of the seating is given by its large and enveloping shapes, expertly reproduced in the seat and back elements. In its version with headrest, Swale represents a refined reading sitting; the low back, on the other hand, allows effective use in contract environments, where Swale brings the best features of a domestic upholstery.

FR Grâce à ses formes généreuses, le fauteuil Swale invite à des conversations détendues dans un environnement résidentiel. Le confort de l'assise est donné par ses formes larges et enveloppantes qui se prolongent avec harmonie par le dossier. Dans sa version avec appuie-tête, Swale devient un siège de lecture raffiné, le modèle Swale avec dossier bas est un siège d'accueil élégant. La gamme Swale s'intègre aisément dans tous les espaces y compris en habitat.

DE Dank seiner runden, großzügigen Struktur sorgt der Sessel Swale für eine entspannte Gesprächsatmosphäre in Wohnräumen genauso wie im öffentlichen Bereich. Durch seine breiten und einhüllenden Formen ist der Sessel besonders komfortabel. Die Version mit Kopfstütze ist besonders geeignet als raffinierter Lesesessel. Die Variante mit niedriger Rückenlehne hingegen ermöglicht auch einen effektiven Einsatz im Objektbereich, wo eine entspannte Atmosphäre gewünscht wird.

SWALE

ARMCHAIR

SWALE cod. 1151
Low armchair with legs /
SCANCARÒ cod. 8830
Coffee table /
TURI TURI cod. 8772_D40
Coffee table



SWALE

SWALE cod. 1151
Low armchair with legs /
SCANCARÒ cod. 8830
Coffee table



ARMCHAIR

SWALE cod. 1151
Low armchair with legs



SWALE

SWALE cod. 1150
High armchair with legs /
SWALE cod. 1151
Low armchair with legs /
ACCURSIO cod. 9030 / 9037
Coffee table /
U cod. 1101
Coffee table



ARMCHAIR

SWALE cod. 1153
Low armchair with uph. base /
SWALE cod. 1152
High armchair with uph. base



SWALE cod. 1150
High armchair with legs



Dati tecnici - Technical data - Données techniques - Technische Angaben

With legs

Upholstered base

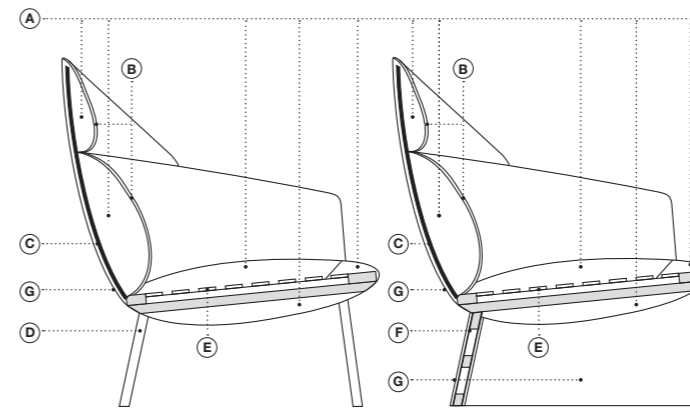

- Legno massiccio di faggio
 - A.** Poliuretano espanso ignifugo a quote differenziate
 - B.** Fibra di poliestere
 - C.** Vetrosesina
 - D.** Acciaio verniciato
 - E.** Cinghie elastiche ad alta densità
 - F.** Pannello di masonite
 - G.** Rivestimento
-
- Bois de hêtre massif
 - A.** Mousse polyuréthane expansé ignifuge indéformable à épaisseurs différenciées
 - B.** Fibre de polyester
 - C.** Fibre de verre
 - D.** Acier laqué
 - E.** Sangles élastiques
 - F.** Panneau de particules
 - G.** Revêtement

- Solid beech
 - A.** Flame-retardant undeformable polyurethane foam of different densities
 - B.** Polyester fibers
 - C.** Fibreglass
 - D.** Lacquered steel
 - E.** High density elastic straps
 - F.** Masonite panels
 - G.** Upholstery
-
- Massivholz aus Buche
 - A.** Feuerfester formbeständige Polyurethanschaum in unterschiedlicher Dichte
 - B.** Polyester
 - C.** Glasfaserkunststoff
 - D.** Lackierter Stahl
 - E.** Elastischen Gurtbändern
 - F.** Holzfasertafel
 - G.** Bezug

Caratteristiche - Features - Caractéristiques - Eigenheiten

- Telaio rinforzato per uso aree pubbliche
 - Poliuretano espanso ignifugo
 - Poliuretano espanso indeformabile a quote differenziate ad alta densità
 - Cuciture rinforzate con supporto in fibra di carbonio
 - Basi personalizzabili con colore su richiesta del cliente
- Reinforced frame for public area use
 - Flame-retardant polyurethane foam
 - Undeformable polyurethane foam of different densities
 - Reinforced stitching with carbon fiber support
 - Bases customizable with other colors on customer's request
- Structure renforcée pour une utilisation en espace public
 - Mousse polyuréthane expansé ignifuge
 - Mousse polyuréthane expansé indéformable à épaisseurs différenciées
 - Coutures renforcées de fibre de carbone
 - Piètements disponibles en autres finitions sur demande
- Verstärkte Holzstruktur für Nutzung bei öffentlichem Bereich
 - Feuerfester Polyurethanschaum
 - Formbeständige Polyurethanschaum in unterschiedlicher Dichte
 - Verstärkte Säume mit Stütz aus Kohlefaser
 - Gestell in Kundenfarben auf Anfrage verfügbar

Coordinati - Matching items - Produits assortis - Abgestimmte Produkte



Finitura base - Base finish - Finition de piètement - Gestell Ausführung

- Avorio
Ivory
Ivoire
Elfenbein
- Fango
Mud
Boue
Schlamm
- Prugna
Plum
Prune
Pflaume
- Nero pece
Pitch black
Poix noir
Pech Schwarz

cod. 1150 / high armchair with legs cod. 1151 / low armchair with legs cod. 1152 / high armchair with uph. base cod. 1153 / low armchair with uph. base

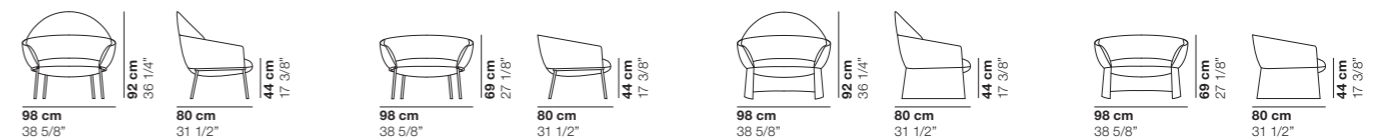

LaCividina srl

**HEADQUARTERS
/ PRODUCTION**

Via Cividina 176
33035 Martignacco
Udine Italy

SHOWROOM

Via Lungolavia 1
33035 Martignacco
Udine Italy

T. + 39 0432 677433
F. + 39 0432 677480
info@lacividina.com
www.lacividina.com



Press Office

Carter&Bennett
pr@carterandbennett.com
tel. +39 0432 1746101

/ La Cividina s.r.l., al fine di migliorare caratteristiche tecniche e qualitative della sua produzione, si riserva di apportare, anche senza preavviso, tutte le modifiche che si rendessero necessarie.

/ With a view to improving the technical characteristics and quality of its products, La Cividina s.r.l. reserves the right to develop its products at any time without notice.

/ Afin d'améliorer les caractéristiques techniques et qualitatives de sa production, La Cividina s.r.l. se réserve d'apporter, même sans préavis, toutes les modifications qui se rendront nécessaires.

/ Zur Verbesserung der technischen und qualitativen Merkmale behält sich La Cividina s.r.l. vor, alle notwendig erscheinenden Produktionsänderungen auch ohne Vorankündigung durchzuführen.

LaCividina is member of the
“Italian Flair & Synergy for Contract”
www.ifscnetwork.com

Company Art Director

Luca Botto

Graphic Design

Designwork

Photo

Alessandro Paderni / Studio Eye

Render

Nudesign Studio

2D/3D development

Federico Bravo

Copywriting

Carter&Bennett

Thanks to

Karpeta

Made and printed in Italy

Grafiche Manzanesi
October 2020

LaCividina s.r.l

**HEADQUARTERS
/ PRODUCTION**

Via Cividina 176
33035 Martignacco
Udine Italy

SHOWROOM

Via Lungolavia 1
33035 Martignacco
Udine Italy

T. + 39 0432 677433

F. + 39 0432 677480

info@lacividina.com

www.lacividina.com