

LC

---

Collection

---

Soave  
Waves

+ 2

laCividina

---

## Collection

---

Soave ARMCHAIR / SOFA

---

Waves OTTOMAN / DORMEUSE / SYSTEM

---



SOAVE cod. 1043  
Left element 178 with right table

## Soave

<b>Family</b>	Armchair / Sofa
<b>Designer</b>	Sebastian Herkner / 2018
<b>Link</b>	<a href="http://www.read-mo.re/soave">www.read-mo.re/soave</a>

**IT** Una collezione di poltrone e divani la cui peculiarità è la ripetizione di un modulo, una forma ellittica che sovrapposta diventa base e seduta mentre curvata crea lo schienale – più discreto, più avvolgente o asimmetrico. Gli angoli smussati e le gambe in metallo, sottili ed essenziali, danno morbidezza e leggerezza a Soave, un progetto dal carattere rigoroso e coerente che, arricchito dal tavolino in appoggio, si rivela perfetto per tutti gli spazi del contract.

**EN** The distinguishing feature of this collection of armchairs and sofas is the use of an elliptic shape in a number of ways. As well as being layered to form a base and a seat, it is curved into a backrest, which may be more discreet, more enveloping or asymmetrical. The rounded corners and the slender, simple metal legs give a soft, light feel to Soave, which has a consistently understated nature. When complemented by the small support table, it is perfect for all uses in the contract market and exhibition venues.

**FR** Une collection de fauteuils et de canapés dont la particularité est la répétition d'un module, une forme elliptique qui, lorsqu'elle est superposée, se transforme en base et en assise et, lorsqu'elle est incurvée, crée le dossier - plus discret, plus enveloppant ou asymétrique. Les coins arrondis et les pieds en métal, fins et essentiels, apportent douceur et légèreté à Soave, un projet au caractère rigoureux et cohérent qui, enrichi par la table d'appoint, est idéal pour tous les espaces professionnels.

**DE** Eine Kollektion mit Sesseln und Sofas, deren Besonderheit ein ellipsenförmiges Modul ist, das sich wiederholt. Übereinander bilden die Module Grund- und Sitzfläche, während die geschwungene Form eine Rückenlehne entstehen lässt – nach Belieben eher zurückhaltend, umhüllend oder asymmetrisch. Die abgerundeten Kanten und die grazilen, schlichten Füße aus Metall verleihen dem Modell Soave Weichheit und Leichtigkeit. Das Projekt besticht durch seinen strengen und konsequenten Charakter und ist mit seinem Beistelltischchen ideal für alle Contract-Bereiche.

SOAVE

ARMCHAIR / SOFA

**SOAVE** cod. 1043  
Left element 178 with right table /  
**CUSHION** cod. 10016 /  
**SOAVE** cod.1031  
Armchair with arms /  
**TURI TURI** cod. 8773\_D50 / 8774\_D70  
Coffee table



**SOAVE** cod. 1035  
3 seater with arms /  
**CUSHION** cod. 10016 / 10023 /  
**SOAVE** cod. 1030  
Armchair /  
**MIL** cod. 9095  
Coffee table



**SOAVE** cod. 1043  
Left element 178 with right table /  
**CUSHION** cod. 10016



**SOAVE** cod. 1031  
Armchair with arms



**SOAVE** cod. 1030  
Armchair



**SOAVE** cod. 1035  
3 seater with arms

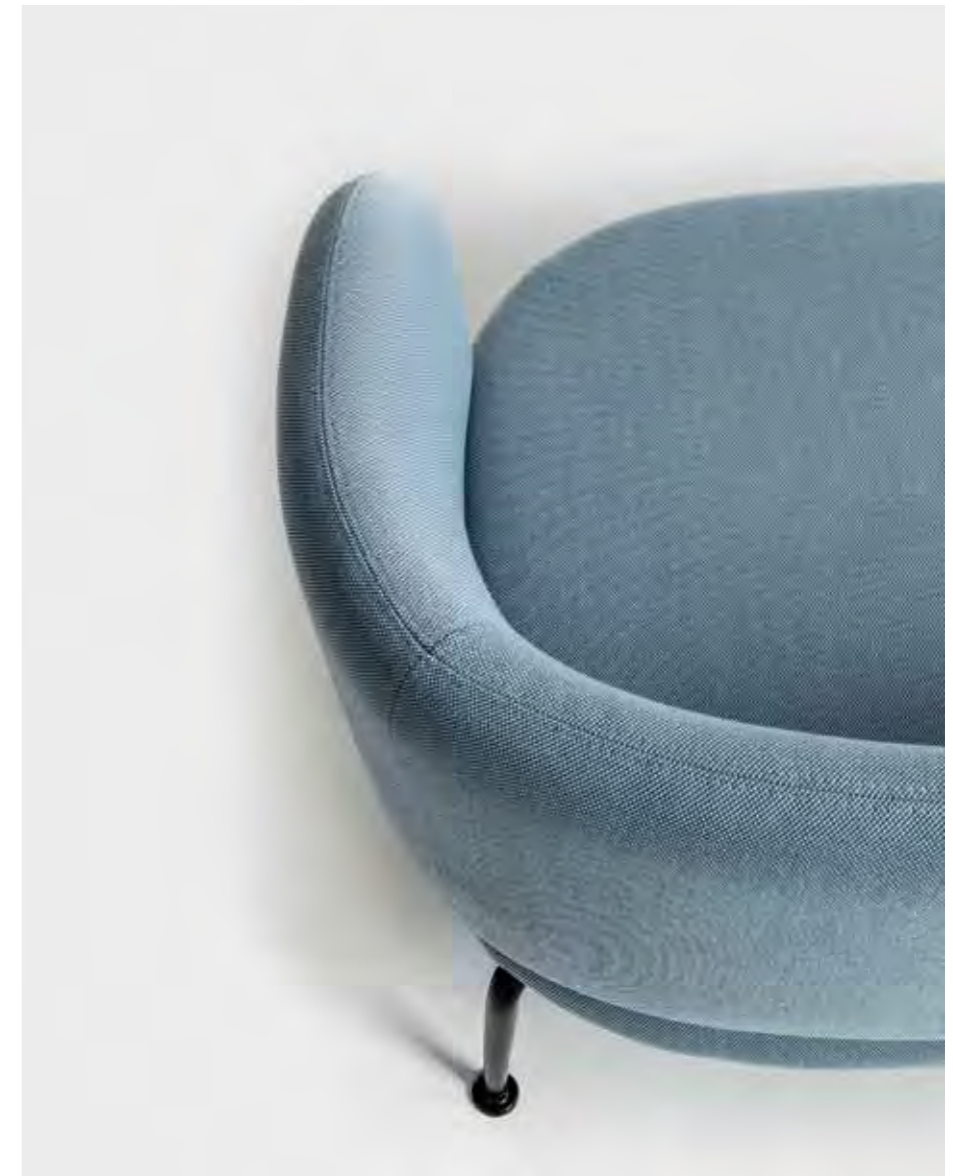

**SOAVE** cod. 1043  
Left element 178 with right table /  
**CUSHION** cod. 10016 /  
**SOAVE** cod. 1031  
Armchair with arms /  
**MIL** cod. 9095 / 9096  
Coffee table





Dati tecnici · Technical data · Données techniques · Technische Angaben

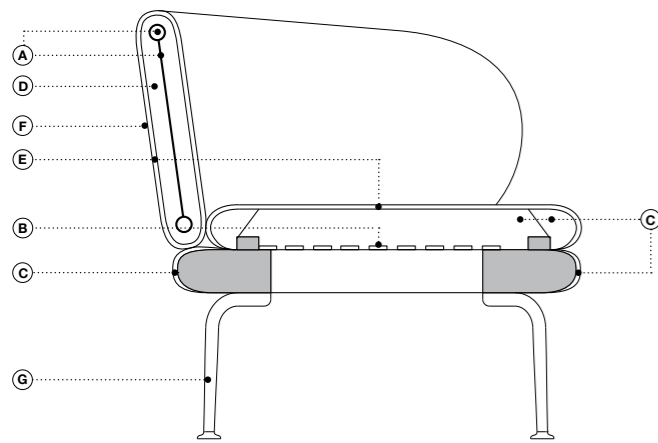

- |  |   |
|--|---|
| <p>■ Legno massiccio di faggio<br/> <b>A.</b> Acciaio<br/> <b>B.</b> Cinghie elastiche ad alta densità<br/> <b>C.</b> Poliuretano espanso ignifugo a quote differenziate<br/> <b>D.</b> Poliuretano ignifugo schiumato a freddo<br/> <b>E.</b> Fibra di poliestere<br/> <b>F.</b> Rivestimento<br/> <b>G.</b> Acciaio verniciato</p> | <p>■ Solid beech<br/> <b>A.</b> Steel<br/> <b>B.</b> High density elastic straps<br/> <b>C.</b> Flame-retardant undecomposable polyurethane foam of different densities<br/> <b>D.</b> Injected flame-retardant foam<br/> <b>E.</b> Polyester fibers<br/> <b>F.</b> Upholstery<br/> <b>G.</b> Lacquered steel</p> |
| <p>■ Bois de hêtre massif<br/> <b>A.</b> Acier<br/> <b>B.</b> Sangles élastiques à haute densité<br/> <b>C.</b> Mousse polyuréthane expansé ignifuge indéformable à épaisseurs différenciées<br/> <b>D.</b> Mousse à froid ignifuge<br/> <b>E.</b> Fibre de polyester<br/> <b>F.</b> Revêtement<br/> <b>G.</b> Acier laqué</p>       | <p>■ Massivholz Buche<br/> <b>A.</b> Stahl<br/> <b>B.</b> Elastische Gurtbänder<br/> <b>C.</b> Feuerfester formbeständiger Polyurethanschaum in unterschiedlicher Dichte<br/> <b>D.</b> Feuerbeständiger Kaltschaum<br/> <b>E.</b> Polyester<br/> <b>F.</b> Bezug<br/> <b>G.</b> Lackierter Stahl</p>             |

Caratteristiche · Features · Caractéristiques · Eigenheiten

- |  |   |   |  |
|--|---|---|--|
| <ul style="list-style-type: none"> <li>· Telaio rinforzato per uso aree pubbliche</li> <li>· Poliuretano espanso ignifugo indeformabile a quote differenziate ad alta densità</li> <li>· Poliuretano ignifugo schiumato a freddo</li> <li>· Cuciture rinforzate con supporto in fibra di carbonio</li> <li>· Piedi personalizzabili con colore su richiesta del cliente</li> </ul> | <ul style="list-style-type: none"> <li>· Reinforced frame for public area use</li> <li>· Undecomposable polyurethane foam of different densities</li> <li>· Injected flame-retardant foam</li> <li>· Reinforced stitching with carbon fiber support</li> <li>· Feet customizable with other colors on customer's request</li> </ul> | <ul style="list-style-type: none"> <li>· Structure renforcée pour une utilisation en espace public</li> <li>· Mousse de polyuréthane expansé ignifuge indéformable à épaisseurs différenciées</li> <li>· Mousse à froid ignifuge</li> <li>· Coutures renforcées de fibre de carbone</li> <li>· Pieds disponibles dans d'autres finitions sur demande</li> </ul> | <ul style="list-style-type: none"> <li>· Verstärkte Holzstruktur für die Nutzung in öffentlichen Bereichen</li> <li>· Formbeständiger Polyurethanschaum in unterschiedlicher Dichte</li> <li>· Feuerfester formbeständiger Polyurethanschaum</li> <li>· Mit Kohlefaser verstärkte Nähte Kohlefaser</li> <li>· Füße werden auf Wunsch des Kunden in anderen Farben gestaltet</li> </ul> |
|--|---|---|--|

Coordinati · Matching items · Produits assortis · Abgestimmte Produkte



Finiture piano · Top finishes · Finitions de plateau · Plattenausführungen

- |   |   |   |   |
|---|---|---|---|
| <p>Rovere spazzolato naturale<br/>         Natural brushed oak<br/>         Chêne brossé naturel<br/>         Eichenholz natur, gebürstet</p> | <p>Rovere spazzolato grafite<br/>         Graphite brushed oak<br/>         Chêne brossé graphite<br/>         Eichenholz Graphit gebürstet</p> | <p>MDF bianco (RAL 9016)<br/>         MDF white (RAL 9016)<br/>         MDF blanc (RAL 9016)<br/>         MDF Weiß (RAL 9016)</p> | <p>MDF nero (RAL 9005)<br/>         MDF black (RAL 9005)<br/>         MDF noir (RAL 9005)<br/>         MDF Schwarz (RAL 9005)</p> |
| <p>Marmo Marquina<br/>         Marquina marble<br/>         Marbre Marquina<br/>         Marquina Marmor</p>                                  | <p>Marmo Carrara<br/>         Carrara marble<br/>         Marbre Carrara<br/>         Carrara Marmor</p>  | <p>Marmo Calacatta<br/>         Calacatta marble<br/>         Marbre Calacatta<br/>         Calacatta Marmor</p>                  |   |

Finitura piedi · Legs finishes · Finition de pieds · Ausführung mit Füßen

- |   |   |  |  |
|---|---|--|--|
| <p>Nero<br/>         Black<br/>         Noir<br/>         Schwarz</p> | <p>Prugna<br/>         Plum<br/>         Prune<br/>         Pflaume</p> | <p>Laccato ottone<br/>         Lacquered brass<br/>         Laqué laiton<br/>         Messing lackiert</p> | <p>Laccato rame<br/>         Lacquered copper<br/>         Laqué cuivre<br/>         Kupfer lackiert</p> |
|---|---|--|--|

cod. 1030 / armchair

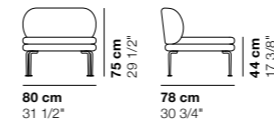

cod. 1031 / armchair with arms

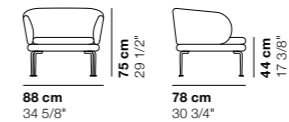

cod. 1032 / 2 seater

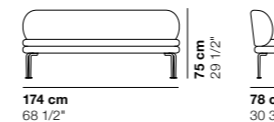

cod. 1033 / 2 seater with arms



cod. 1034 / 3 seater

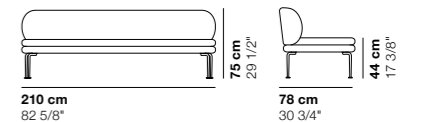

cod. 1035 / 3 seater with arms

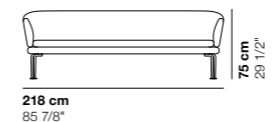

cod. 1036 / right element 178



cod. 1037 / left element 178

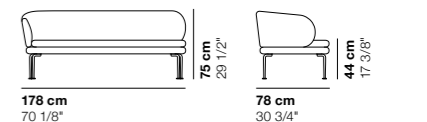

cod. 1038 / right element 214

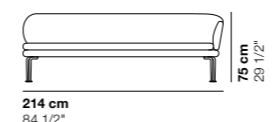

cod. 1039 / left element 214

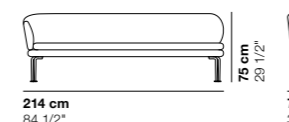

cod. 1040 / element 174 with right table

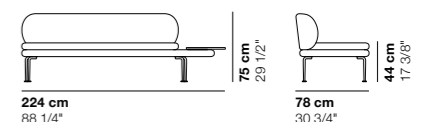

cod. 1041 / element 174 with left table

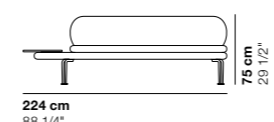

cod. 1042 / right element 178 with left table

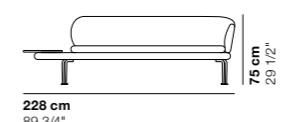

cod. 1043 / left element 178 with right table

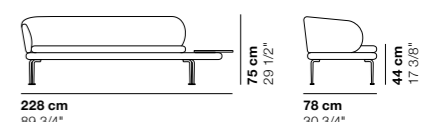



**WAVES** cod. 1010  
Diamond ottoman /  
**WAVES** cod. 1013  
Parallel ottoman with backrest /  
**WAVES** cod. 1014  
Trapezium ottoman /  
**MIL** cod. 9095  
Coffee table

## Waves

<b>Family</b>	Ottoman / Dormeuse / System
<b>Designer</b>	Constance Guisset / 2018
<b>Link</b>	<a href="http://www.read-mo.re/waves">www.read-mo.re/waves</a>

**IT** Waves è una collezione di pouf ispirata al mare, alle onde morbide e gentili che increspano la superficie dell'acqua. Forme organiche che si fanno artistiche, in cui paesaggi e fiori invadono la tela con linee sinuose e colori pieni. Waves è elemento singolo ma è soprattutto composizione. Moduli con forme e volumi diversi, anche con piccolo schienale, da affiancare a piacere per arredare in modo elegante e inconsueto luoghi d'attesa o spazi espositivi. Ogni elemento nasconde nella struttura un magnete, grazie al quale i pouf si agganciano tra di loro. Completa la collezione una serie di tavolini in legno che, in linea con il nostro vivere contemporaneo, nascondono prese elettriche e USB.



**EN** Waves is a collection of poufs inspired by the sea and the soft, gentle ripples running along the surface of the water. Natural forms take on an artistic character, with the winding lines and rich colours of landscapes and flowers flooding onto the canvases. Waves poufs can be used individually, but they really come into their own in compositions. The modular items are available in a range of different shapes and sizes, including some with small backrests. They can be joined together however you like as part of a refined, original interior design scheme for waiting rooms and exhibition venues. There is a magnet hidden inside the structure of each pouf, so a number of the items can be joined together. Rounding off the collection is a selection of wooden coffee tables with concealed plug sockets and USB ports to cater to the needs of contemporary living.

**FR** Waves est une collection de poufs s'inspirant de la mer, des vagues souples et douces qui animent la surface de l'eau. Des formes organiques qui deviennent artistiques, dans lesquelles les paysages et les fleurs envahissent la toile avec des lignes sinueuses et des couleurs pleines. Waves est un élément unique mais est surtout une composition. Des modules de formes et de volumes différents, également proposés avec un petit dossier, à placer côte à côte pour meubler, de façon élégante et insolite, les salles d'attente ou les espaces d'exposition. La structure de chaque élément renferme un aimant, permettant aux poufs d'être raccordés entre eux. La collection est complétée par une série de tables basses en bois qui, en accord avec notre style de vie contemporain, cachent des prises électriques et USB.

**DE** Die Pouf-Kollektion Waves wird vom Meer und weichen, sanften Wellen inspiriert, die sacht die Oberfläche des Wassers kräuseln. Organische, Künstlerisch wirkende Formen, die von Landschaften und Blumen mit geschmeidigen Formen und kräftigen Farben überflutet werden. Waves ist ein einzelnes Element, aber vor allem als Komposition konzipiert. Module in verschiedenen Formen und Größen, auch mit kleiner Rückenlehne, die ganz nach Wunsch für die Gestaltung von eleganten, ungewöhnlichen Warte- und Ausstellungsräumen zusammengestellt werden. In der Struktur jedes Elements ist ein Magnet verborgen, mithilfe dessen die Polsterhocker miteinander verbunden werden können. Ergänzt wird die Kollektion durch eine Reihe von kleinen Tischen aus Holz, die – ganz im Zeitgeist – unauffällig mit Steckdosen und USB-Ports ausgerüstet sind.

**WAVES** cod. 1010  
Diamond ottoman /  
**MIL** cod. 9095 / 9096  
Coffee table



**WAVES** cod. 1010  
Diamond ottoman



**WAVES** cod. 1011  
Diamond ottoman with backrest



**WAVES** cod. 1014  
Trapezium ottoman /  
**WAVES** cod. 1015  
Trapezium ottoman with backrest /  
**WAVES** cod. 1012  
Parallel ottoman /  
**WAVES** cod. 1013  
Parallel ottoman with backrest





**WAVES** cod. 1016  
 Leaf dormeuse



**WAVES** cod. 1016  
Leaf dormeuse /  
**MIL** cod. 9095 / 9096  
Coffee table



WAVES

OTTOMAN / DORMEUSE / SYSTEM

WAVES cod. 1010  
Diamond ottoman /  
WAVES cod. 1011  
Diamond ottoman with backrest /  
WAVES cod. 1017  
Hexagon ottoman

EIGHT ELEMENTS  ENDLESS COMPOSITIONS

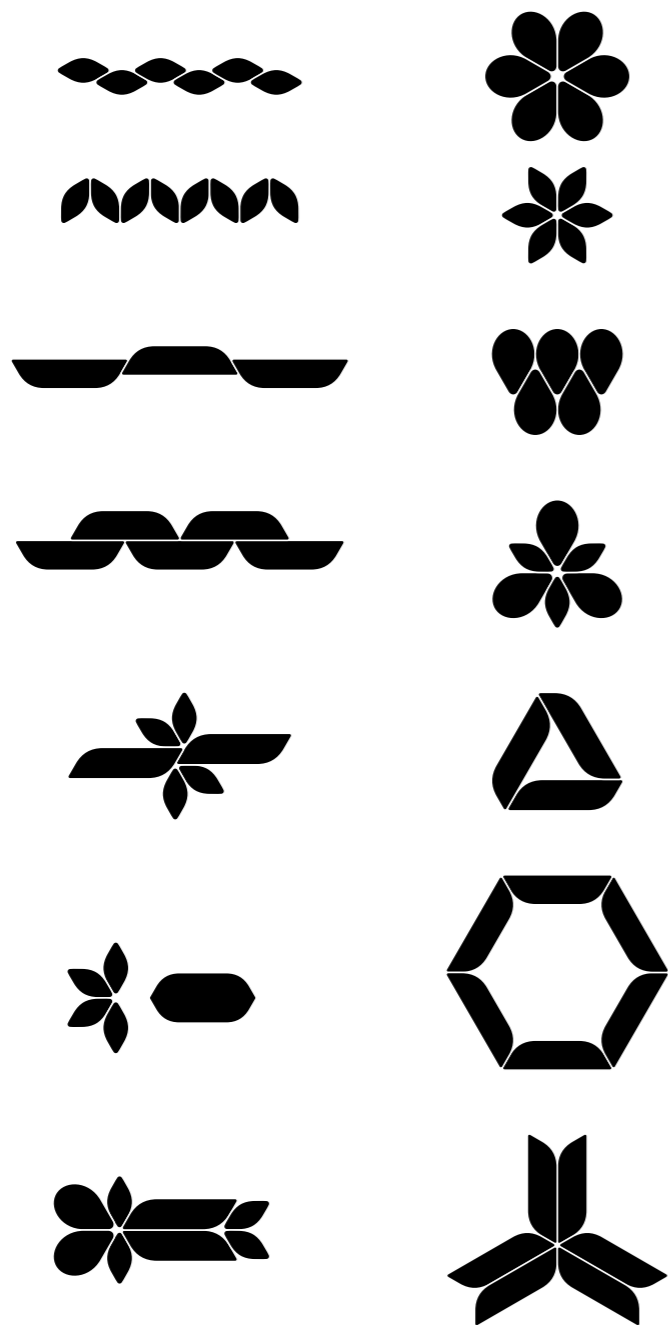

**WAVES** cod. 1015  
 Trapezium ottoman with backrest /  
**WAVES** cod. 1014  
 Trapezium ottoman /  
**WAVES** cod. 1013  
 Parallel ottoman with backrest /  
**WAVES** cod. 1012  
 Parallel ottoman /  
**TURI TURI** cod. 8772\_D40  
 Coffee table /  
**MIL** cod. 9095 / 9096  
 Coffee table



Dati tecnici · Technical data · Données techniques · Technische Angaben

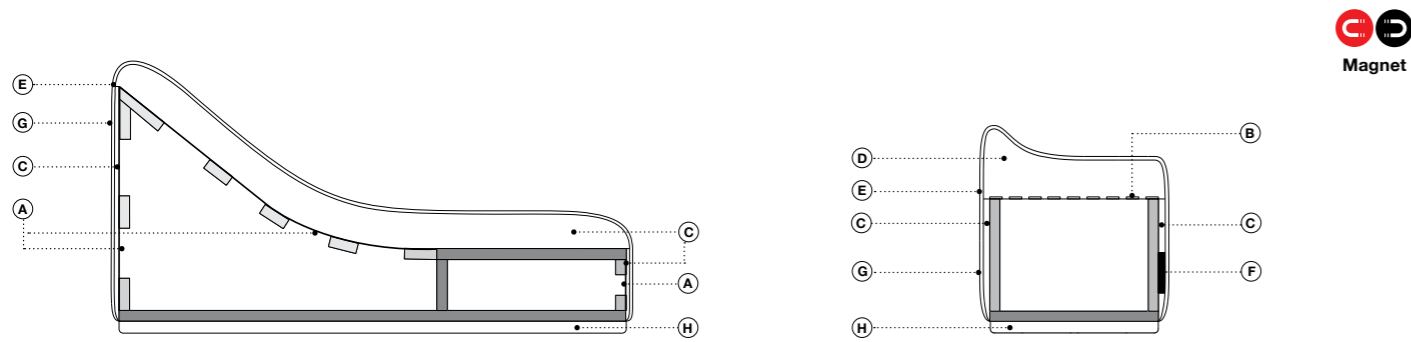

- |  |  |   |  |
|--|--|---|--|
| <ul style="list-style-type: none"> <li>■ Legno massiccio di abete</li> <li>■ Legno massiccio di faggio</li> <li>■ Legno multistrato di faggio</li> <li><b>A.</b> Pannello masonite</li> <li><b>B.</b> Cinghie elastiche ad alta densità</li> <li><b>C.</b> Poliuretano espanso ignifugo a quote differenziate</li> <li><b>D.</b> Poliuretano ignifugo schiumato a freddo</li> <li><b>E.</b> Fibra di poliestere</li> <li><b>F.</b> Magnete</li> <li><b>G.</b> Rivestimento</li> <li><b>H.</b> MDF</li> </ul> | <ul style="list-style-type: none"> <li>■ Solid fir</li> <li>■ Solid beech</li> <li>■ Multilayered beech</li> <li><b>A.</b> Masonite panel</li> <li><b>B.</b> High density elastic straps</li> <li><b>C.</b> Flame-retardant undeformable polyurethane foam of different densities</li> <li><b>D.</b> Injected flame-retardant foam</li> <li><b>E.</b> Polyester fibers</li> <li><b>F.</b> Magnet</li> <li><b>G.</b> Upholstery</li> <li><b>H.</b> MDF</li> </ul> | <ul style="list-style-type: none"> <li>■ Bois de sapin massif</li> <li>■ Bois de hêtre massif</li> <li>■ Multiplis de hêtre</li> <li><b>A.</b> Panneau de particules</li> <li><b>B.</b> Sangles élastiques à haute densité</li> <li><b>C.</b> Mousse polyuréthane expansé ignifuge indéformable à épaisseurs différenciées</li> <li><b>D.</b> Mousse à froid ignifuge</li> <li><b>E.</b> Fibre de polyester</li> <li><b>F.</b> Aimant</li> <li><b>G.</b> Revêtement</li> <li><b>H.</b> MDF</li> </ul> | <ul style="list-style-type: none"> <li>■ Massivholz Tanne</li> <li>■ Massivholz Buche</li> <li>■ Buchenschichtholz</li> <li><b>A.</b> Holzfaserplatte</li> <li><b>B.</b> Elastische Gurtbänder</li> <li><b>C.</b> Feuerfester formbeständiger Polyurethanschaum in unterschiedlicher Dichte</li> <li><b>D.</b> Feuerbeständiger Kaltschaum</li> <li><b>E.</b> Polyester</li> <li><b>F.</b> Magnet</li> <li><b>G.</b> Bezug</li> <li><b>H.</b> MDF</li> </ul> |
|--|--|---|--|

Caratteristiche · Features · Caractéristiques · Eigenheiten

- |  |  |  |   |
|--|--|--|---|
| <ul style="list-style-type: none"> <li>· Telaio rinforzato per uso aree pubbliche</li> <li>· Poliuretano espanso ignifugo indeformabile a quote differenziate ad alta densità</li> <li>· Poliuretano ignifugo schiumato a freddo</li> <li>· Cuciture rinforzate con supporto in fibra di carbonio</li> <li>· Sedute modulari agganciabili con magnete</li> </ul> | <ul style="list-style-type: none"> <li>· Reinforced frame for public area use</li> <li>· Undeformable polyurethane foam of different densities</li> <li>· Injected flame-retardant foam</li> <li>· Reinforced stitching with carbon fiber support</li> <li>· Modular seats to be joined with magnet</li> </ul> | <ul style="list-style-type: none"> <li>· Structure renforcée pour une utilisation en espace public</li> <li>· Mousse polyuréthane expansé ignifuge indéformable à épaisseurs différenciées</li> <li>· Mousse à froid ignifuge</li> <li>· Coutures renforcées de fibre de carbone</li> <li>· Sieges modulaires à joindre avec aimant</li> </ul> | <ul style="list-style-type: none"> <li>· Verstärkte Holzstruktur für die Nutzung in öffentlichen Bereichen</li> <li>· Formbeständige Polyurethanschaum in unterschiedlicher Dichte</li> <li>· Feuerfester formbeständige Polyurethanschaum</li> <li>· Verstärkte Säume mit Stütz aus Kohlefaser</li> <li>· Modular Sitze mit Magnet verbindbar</li> </ul> |
|--|--|--|---|

Coordinati · Matching items · Produits assortis · Abgestimmte Produkte



Finiture · Finishes · Finitions · Ausführungen

- Grigio scuro (RAL 7021)
- Dark grey (RAL 7021)
- Gris foncé (RAL 7021)
- Dunkelgrau (RAL 7021)

cod. 1010 / diamond ottoman

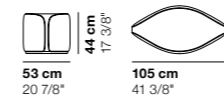

cod. 1011 / diamond ottoman with backrest

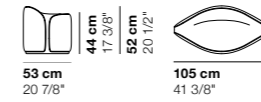

cod. 1012 / parallel ottoman

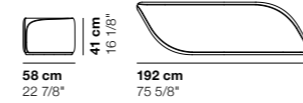

cod. 1013 / parallel ottoman with backrest

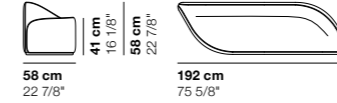

cod. 1014 / trapezium ottoman

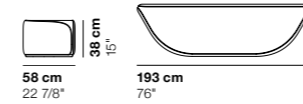

cod. 1015 / trapezium ottoman with backrest

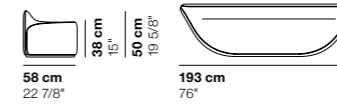

cod. 1016 / leaf dormeuse

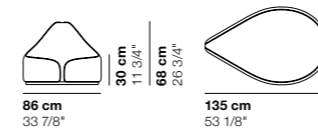

cod. 1017 / hexagon ottoman

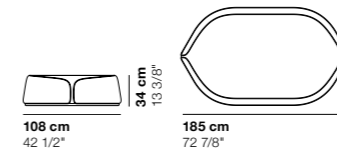

cod. 1018 / coffee table

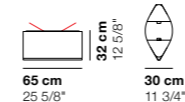

---

**LaCividina srl**

---

**HEADQUARTERS  
/ PRODUCTION**

Via Cividina 176  
33035 Martignacco  
Udine Italy

**SHOWROOM**

Via Lungolavia 1  
33035 Martignacco  
Udine Italy

T. + 39 0432 677433  
F. + 39 0432 677480  
info@lacividina.com  
www.lacividina.com



---

**Press Office**

---

Carter&Bennett  
pr@carterandbennett.com  
tel. +39 0432 1746101

/ La Cividina s.r.l., al fine di migliorare caratteristiche tecniche e qualitative della sua produzione, si riserva di apportare, anche senza preavviso, tutte le modifiche che si rendessero necessarie.

/ With a view to improving the technical characteristics and quality of its products, La Cividina s.r.l. reserves the right to develop its products at any time without notice.

/ Afin d'améliorer les caractéristiques techniques et qualitatives de sa production, La Cividina s.r.l. se réserve d'apporter, même sans préavis, toutes les modifications qui se rendront nécessaires.

/ Zur Verbesserung der technischen und qualitativen Merkmale behält sich La Cividina s.r.l. vor, alle notwendig erscheinenden Produktionsänderungen auch ohne Vorankündigung durchzuführen.

---

**Company Art Director**

---

Luca Botto

---

**Graphic Design**

---

Designwork

---

**Photo**

---

Alessandro Paderni / Studio Eye

---

**Colour Separation**

---

Luce Group

---

**2D development**

---

Federico Bravo

---

**Copywriting**

---

Carter&Bennett

---

**Translation**

---

Trad&Co

---

**Made and printed in Italy**

---

Grafiche Manzanesi

April 2018

**LaCividina s.r.l**

**HEADQUARTERS  
/ PRODUCTION**

Via Cividina 176  
33035 Martignacco  
Udine Italy

**SHOWROOM**

Via Lungolavia 1  
33035 Martignacco  
Udine Italy

T. + 39 0432 677433

F. + 39 0432 677480

info@lacividina.com

www.lacividina.com