

# GUEST

Armchair, Sofa, Ottoman, System

Antonio Rodriguez,  
2015

laCividina



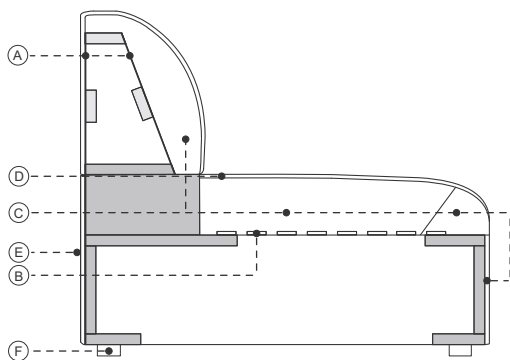

- |  |   |  |  |
|--|---|--|--|
| ■ Legno massiccio di abete   | ■ Solid fir   | ■ Bois de sapin massif   | ■ Massivholz aus Tanne   |
| ■ Legno massiccio di faggio  | ■ Solid beech   | ■ Bois de hêtre massif   | ■ Massivholz aus Buche   |
| <b>A.</b> Pannello di masonite   | <b>A.</b> Masonite panels   | <b>A.</b> Panneau de particules  | <b>A.</b> Holzfaserplatte  |
| <b>B.</b> Cinghie elastiche ad alta densità                                | <b>B.</b> High density elastic straps   | <b>B.</b> Sangles élastiques   | <b>B.</b> Elastischen Gurtbändern  |
| <b>C.</b> Poliuretano espanso ignifugo indeformabile a quote differenziate | <b>C.</b> Flame-retardant undeformable polyurethane foam of different densities | <b>C.</b> Mousse polyuréthane expansé ignifuge indéformable à épaisseurs différenciées | <b>C.</b> Feuerfester formbeständige Polyurethanschäum in unterschiedlicher Dichte |
| <b>D.</b> Fibra di poliestere  | <b>D.</b> Polyester fibers  | <b>D.</b> Fibre de polyester   | <b>D.</b> Polyester  |
| <b>E.</b> Rivestimento fisso in tessuto o pelle                            | <b>E.</b> Fixed upholstery in fabric or leather                                 | <b>G.</b> Revêtement pas déhoussable en tissu ou cuir                                  | <b>E.</b> Unabziehbarer Bezug aus Stoff oder Leder                                 |
| <b>F.</b> Polipropilene nero   | <b>F.</b> Black polypropylene   | <b>F.</b> Polypropylène noir   | <b>F.</b> Schwarz Polypropylen   |

**NOTE  
NOTES  
ANNOTATION  
ANMERKUNG**

- |   |   |  |   |
|---|---|--|---|
| ■ Prodotto disponibile su misura con preventivo su richiesta            | ■ This item can be tailor made with price on request                      | ■ Collection personnalisable sur demande                                       | ■ Produkt nach Maß verfügbar auf Anfrage                              |
| ■ Su richiesta attacco per connessione elettrica e USB con sovrapprezzo | ■ Electrical connection and USB upon request with upcharge                | ■ Sur demande connection électrique et USB avec surcoût                        | ■ Elektrische Verbindung und USB-Anschluss auf Anfrage gegen Aufpreis |
| ■ Cuscini extra disponibili   | ■ Extra cushions available  | ■ Autres coussins disponibles  | ■ Weitere Kissen verfügbar  |
| ■ COM: tessuto cliente (tinta unita e h.140 cm.) - campione richiesto   | ■ COM: client's fabric (plain colour and width 140 cm.) - sample required | ■ COM: tissu fourni (couleur unie et hauteur 140 cm.) - échantillon nécessaire | ■ COM: Kundenstoff (einfarbig und Breite 140 cm.) - Stoffmuster nötig |
| ■ COL: pelle cliente - campione richiesto                               | ■ COL: client's leather - sample required                                 | ■ COL: cuir fourni - échantillon nécessaire                                    | ■ COL: Kundenleder - Ledermuster nötig                                |

**SISTEMA DI AGGANCIAMENTO  
SYSTEM CONNECTOR  
SYSTEME D'ASSEMBLAGE  
VERBINDUNGSHAKEN**



Sistema di aggancio tra elementi  
Components connector  
Systeme d'assemblage de socle  
Verbindungssystem zwischen Elementen

**OPZIONE  
OPTION  
OPTION  
OPZION**



Su richiesta attacco per connessione elettrica e USB con sovrapprezzo  
Electrical connection and USB upon request with upcharge  
Sur demande connection électrique et USB avec surcoût  
Elektrische Verbindung und USB-Anschluss auf Anfrage gegen Aufpreis

**RIVESTIMENTI CONSIGLIATI  
RECOMMENDED COVERINGS  
REVÊTEMENTS CONSEILLÉS  
EMPFOHLENE BEZÜGE**

**CAT. START**  
RINGO  
OPUS

**CAT. A**  
XTREME  
TAILOR  
ANGEL  
MEDLEY  
SAMAR  
AVON  
MAGNUM  
AUTUMN  
HANGO

**CAT. B**  
FAME  
MAIN LINE FLAX  
HESTAN  
SILVERTEX  
GEIKO

**CAT. C**  
SUPERB  
TREND  
KEN BI  
MIKONOS  
ANDROS  
ACAPULCO

**CAT. SUPER**  
ORSETTO  
REMIX 3  
MYLLA  
TWISTED FLOWER  
DHARMA DIS.400  
DHARMA DIS.200  
DHARMA DIS.600  
DHARMA DIS.100  
DHARMA DIS.500  
DIVA DIS.01

**CAT. EXTRA**  
STEELCUT TRIO 3  
ARIANA  
OPERA  
ARCO  
CREDO  
TRIO  
BIT  
DIVA DIS.05  
DIVA DIS.21  
DIVA DIS.29

**CAT.MAXI**  
UNIFORM MÉLANGE  
HALLINGDAL 65  
DIVINA 3

**CAT. TOP**  
ARDA  
REGOS

**CAT. SPECIAL**  
GENTLE 2

**CAT. LUX**  
LUX 1  
LUX 2

**CAT. IMPERIAL**  
IMPERIAL 1  
IMPERIAL 2

**POLTRONA  
ARMCHAIR  
FAUTEUIL  
SESSEL**

**COD.9022  
SMALL ARMCHAIR**

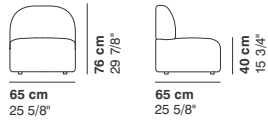

**COD.9000  
ARMCHAIR**

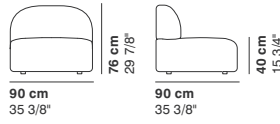

**DIVANI  
SOFAS  
CANAPÉS  
SOFAS**

**COD. 9001  
2 SEATER**

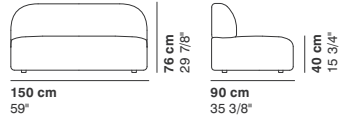

**COD.9002  
2 SEATER MAJOR**

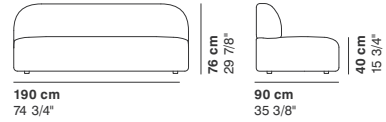

**COD. 9003  
3 SEATER**

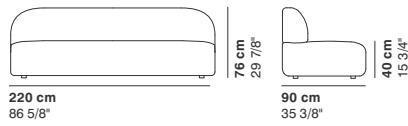

**COD. 9004  
RIGHT PENINSULA**

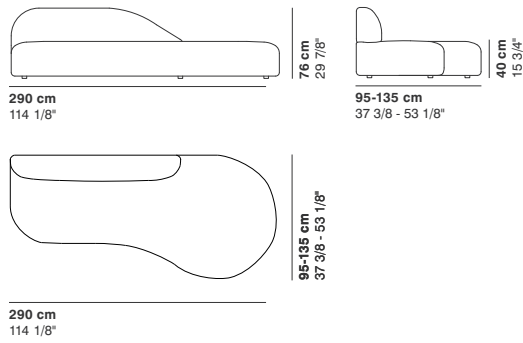

**COD. 9005  
LEFT PENINSULA**

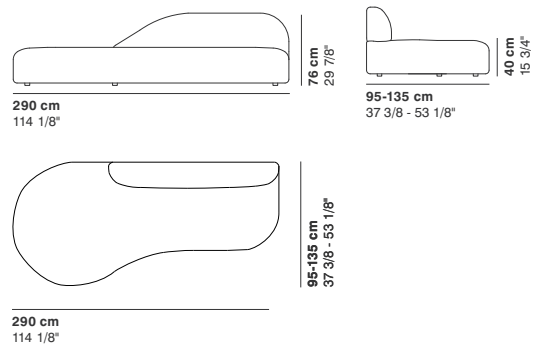

**COD. 9025  
SMALL RIGHT PENINSULA**

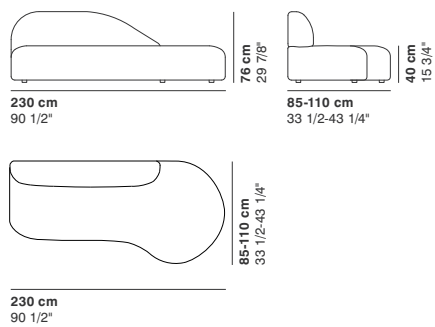

**COD. 9026  
SMALL LEFT PENINSULA**

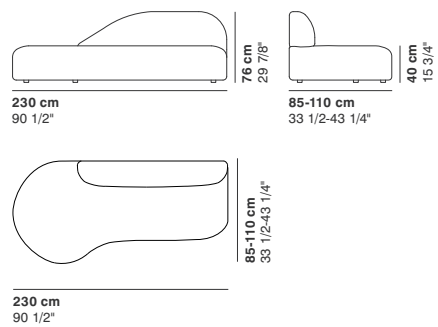

**COMPONIBILI  
SYSTEM  
CANAPÉS MODULAIRES  
MODULAR SOFAS**

**COD. 9006  
ELEMENT 100**

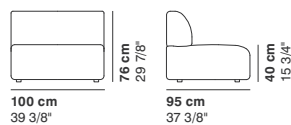

**COD. 9007  
ELEMENT 150**

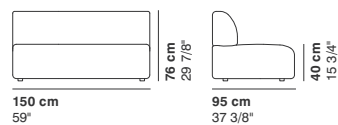

**COD. 9008**  
LEFT ELEMENT 124

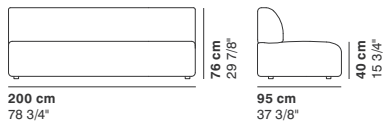

**COD. 9009**  
RIGHT ELEMENT 150

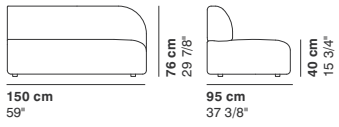

**COD. 9010**  
LEFT ELEMENT 150

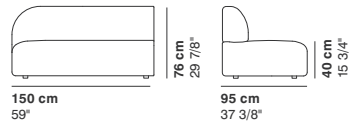

**COD. 9011**  
RIGHT ELEMENT 200

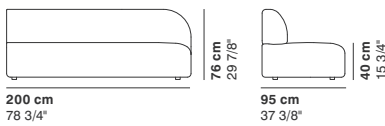

**COD. 9012**  
LEFT ELEMENT 200

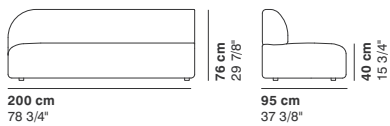

**COD. 9013**  
RIGHT ELEMENT PENINSULA

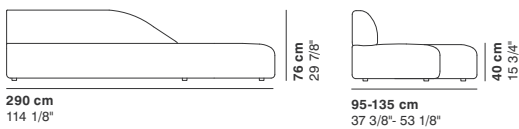

**COD. 9014**  
LEFT ELEMENT PENINSULA

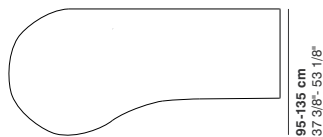
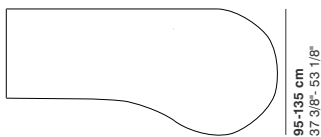
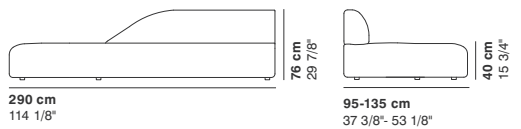

290 cm  
114 1/8"

290 cm  
114 1/8"

**COD. 9015**  
OPEN ELEMENT CURVED 100

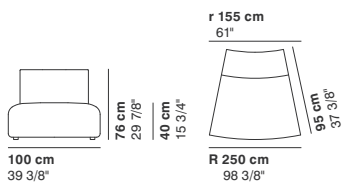

**COD. 9016**  
CLOSED ELEMENT CURVED 100

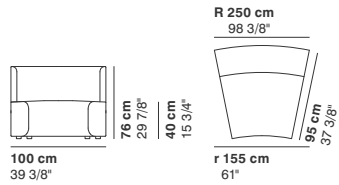

**COD. 9017**  
CLOSED ELEMENT CURVED 200

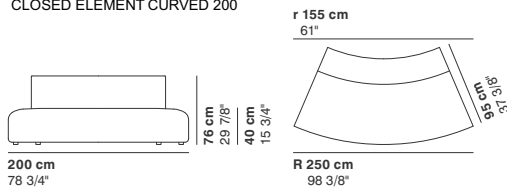

**COD. 9018**  
CLOSED ELEMENT CURVED 200

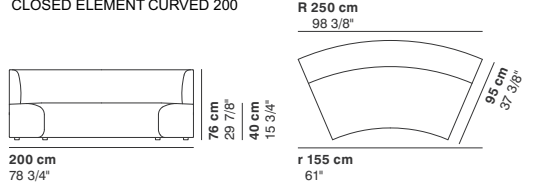

**COD. 9019**  
OTTOMAN D70

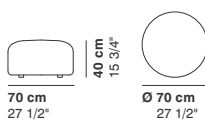

**COD. 9020**  
OTTOMAN D100

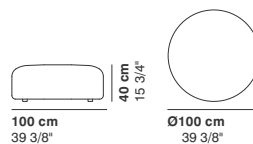

**COD. 9021**  
OTTOMAN D130

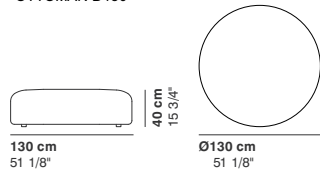

COMPOSITION  
COMPOSITION  
COMPOSITION  
COMPOSITION

**GUE01**  
COMPOSITION

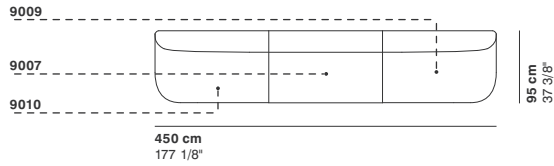

**GUE02**  
COMPOSITION

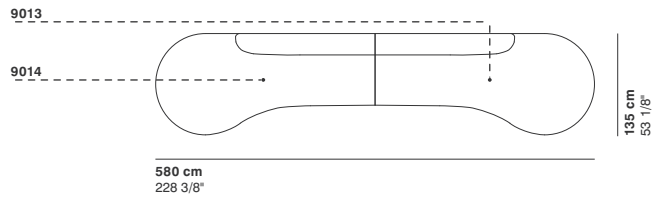

**GUE03**  
COMPOSITION

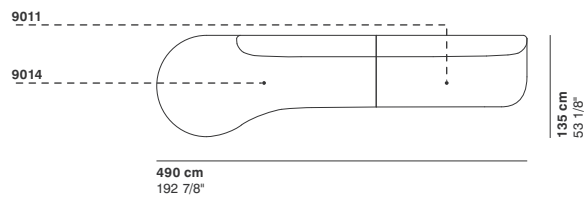

**GUE05**  
COMPOSITION

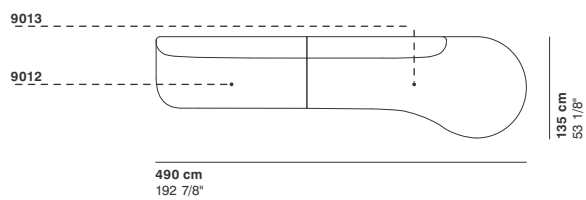

**GUE05**  
COMPOSITION

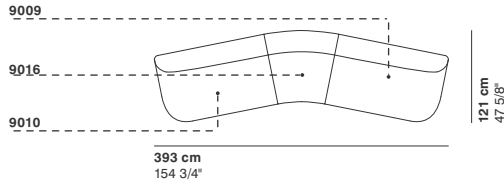

**GUE06**  
COMPOSITION

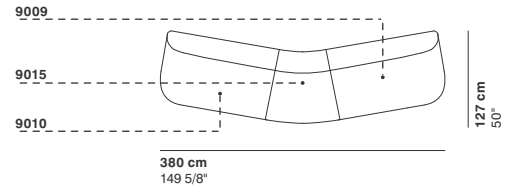

**GUE07**  
COMPOSITION

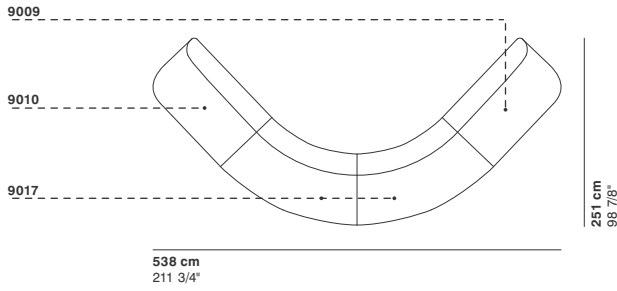

**GUE08**  
COMPOSITION

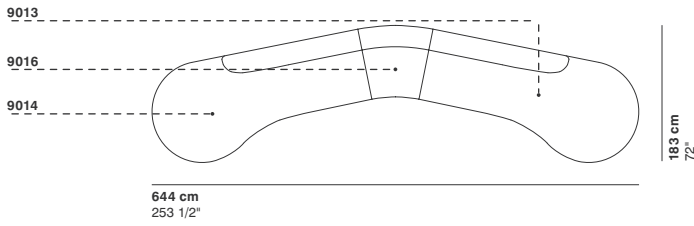

---

La Cividina s.r.l., al fine di migliorare le caratteristiche tecniche e qualitative della sua produzione, si riserva di apportare, anche senza preavviso, tutte le modifiche che si rendessero necessarie.

With a view to improving the technical characteristics and quality of its products la Cividina s.r.l. reserves the right to develop its products at anytime without notice.

A fin d'améliorer les caractéristiques de sa production, La Cividina s.r.l. se réserve d'apporter, même sans préavis, toutes les modifications qui se rendrot nécessaires.

Zur Verbesserung, der technischen und qualitativen Merkmale, behält sich La Cividina s.r.l. vor, alle notwending erscheinenden Produktionsänderungen, auch ohne Vorankündigung durchzuführen.

---

**LA CIVIDINA S.R.L.**

**HEADQUARTERS / PRODUCTION**

Via Spilimbergo 162  
33035 Martignacco  
Udine Italy  
T +39 0432 677433  
F +39 0432 677480  
[info@lacividina.com](mailto:info@lacividina.com)  
[lacividina.com](http://lacividina.com)

**ISO 9001**



**SHOWROOM MARTIGNACCO**

Via Lungolavia 1  
33035 Martignacco  
Udine Italy  
T +39 0432 677433

**SHOWROOM MILANO**

Palazzo Borromeo  
Via Manzoni 41  
20121 Milano  
Italy  
T +39 345 8350810