Guest

Family

Armchair / Sofa / Ottoman /
System

Designer

Antonio Rodriguez / 2015

Link

www.read-mo.re/guest



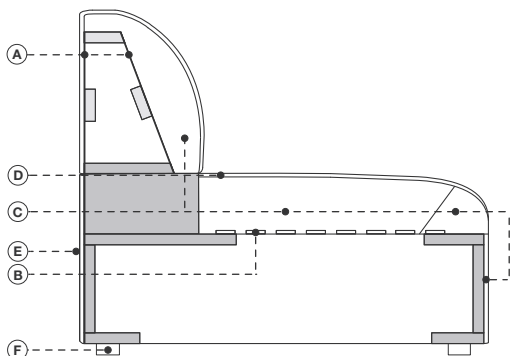

- | | | | |
|--|---|--|--|
| ■ Legno massiccio di abete | ■ Solid fir | ■ Bois de sapin massif | ■ Massiveholz aus Tanne |
| ■ Legno massiccio di faggio | ■ Solid beech | ■ Bois de hêtre massif | ■ Massiveholz aus Buche |
| A. Pannello di masonite | A. Masonite panels | A. Panneau de particules | A. Holzfaserplatte |
| B. Cinghie elastiche ad alta densità | B. High density elastic straps | B. Sangles élastiques | B. Elasytischen Gurtbändern |
| C. Poliuretano espanso ignifugo indeformabile a quote differenziate | C. Flame-retardant undeformable polyurethane foam of different densities | C. Mousse polyuréthane expansé ignifuge indéformable à épaisseurs différenciées | C. Feuerfester formbeständige Polyurethanschaum in unterschiedlicher Dichte |
| D. Fibra di poliestere | D. Polyester fibers | D. Fibre de polyester | D. Polyester |
| E. Rivestimento fisso in tessuto o pelle | E. Fixed upholstery in fabric or leather | G. Revêtement pas déhoussable en tissu ou cuir | E. Unabziehbarer Bezug aus Stoff oder Leder |
| F. Polipropilene nero | F. Black polypropylene | F. Polypropylène noir | F. Schwarz Polypropylen |

Note · Notes · Annotation · Anmerkung

- | | | | |
|---|---|--|---|
| <ul style="list-style-type: none"> • Prodotto disponibile su misura con preventivo su richiesta • Su richiesta attacco per connessione elettrica e USB con sovrapprezzo • Cuscini extra disponibili • COM: tessuto cliente (tinta unita e h.140 cm.) - campione richiesto • COL: pelle cliente - campione richiesto • CAT. SPECIAL: prezzo e disponibilità su richiesta | <ul style="list-style-type: none"> • This item can be tailor made with price on request • Electrical connection and USB upon request with upcharge • Extra cushions available • COM: client's fabric (plain colour and width 140 cm.) - sample required • COL: client's leather - sample required • CAT. SPECIAL: price and availability upon request | <ul style="list-style-type: none"> • Collection personnalisable sur demande • Sur demande connection électrique et USB avec surcoût • Autres coussins disponibles • COM: tissu fourni (couleur unie et hauteur 140 cm.) - échantillon nécessaire • COL: cuir fourni - échantillon nécessaire • CAT. SPECIAL: prix et disponibilité sur demande | <ul style="list-style-type: none"> • Produkt nach Maß verfügbar auf Anfrage • Elektrische Verbindung und USB-Anschluss auf Anfrage gegen Aufpreis • Weitere Kissen verfügbar • COM: Kundenstoff (einfarbig und Breite 140 cm.) - Stoffmuster nötig • COL: Kundenleder - Ledermuster nötig • CAT. SPECIAL: Preis und Verfügbarkeit auf Anfrage |
|---|---|--|---|

Opzione · Option · Option · Opzion



Su richiesta attacco per connessione elettrica e USB con sovrapprezzo
 Electrical connection and USB upon request with upcharge
 Sur demande connection électrique et USB avec surcoût
 Elektrische Verbindung und USB-Anschluss auf Anfrage gegen Aufpreis

Sistema di aggancio · System connector · Systeme d'assemblage · Verbindungshaken



Sistema di aggancio tra elementi
 Components connector
 Systeme d'assemblage de socle
 Verbindungssystem zwischen Elemente

Rivestimenti consigliati · Recommended coverings · Revêtements conseillées · Empfohlene Bezüge

- | | | | | | | | |
|----------|----------------|--------------|----------|--------------|-----------------|-----------------|-----------------|
| * cat. A | XTREME | * cat. C | SUPERB | * cat. extra | RIME | * cat. maxi | MOSAIC 2 |
| * cat. A | TAILOR | * cat. C | DEANS | * cat. extra | MOLLY 2 | * cat. maxi | UNIFORM MÉLANGE |
| * cat. A | ANGEL | * cat. C | IRIS | * cat. extra | STEELCUT TRIO 3 | * cat. maxi | HALLINGDAL 65 |
| * cat. A | SAMAR | * cat. C | TREND | * cat. extra | ARIANA | * cat. maxi | DIVINA 3 |
| * cat. A | AVON | * cat. super | AMELIA | * cat. extra | COLLINE | * cat. top | ARDA |
| * cat. A | MAGNUM | * cat. super | NOX | * cat. extra | OPERA | * cat. special | TRIANGLE |
| * cat. A | CRAZY | * cat. super | ORSETTO | * cat. extra | ARCO | * cat. special | GENTLE 2 |
| * cat. B | WILSON | * cat. super | REMIX 3 | * cat. extra | CREDO | * cat. special | SISU |
| * cat. B | FAME | * cat. super | TERASKIN | * cat. extra | CLEO | * cat. lux | LUX 1 |
| * cat. B | MAIN LINE FLAX | * cat. super | FOSTER | * cat. extra | TRIO | * cat. lux | LUX 2 |
| * cat. B | STRETCHY | | | * cat. extra | BIT | * cat. imperial | IMPERIAL 1 |
| * cat. B | HERO | | | | | * cat. imperial | IMPERIAL 2 |
| * cat. B | HESTAN | | | | | | |
| * cat. B | SATEN | | | | | | |
| * cat. B | SILVERTEX | | | | | | |

GUEST

cod. 9000 / **armchair**

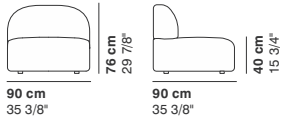

cod. 9001 / **2 seater**

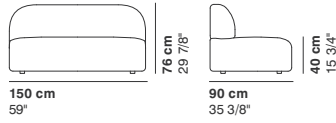

cod. 9002 / **2 seater major**

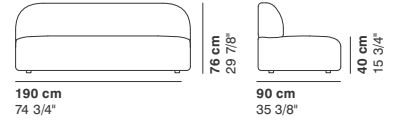

cod. 9003 / **3 seater**

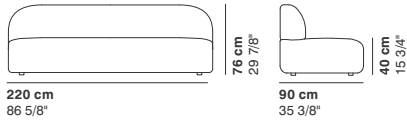

cod. 9004 / **right peninsula**

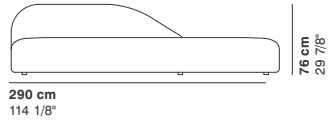

cod. 9005 / **left peninsula**

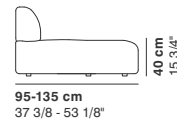
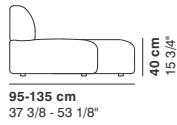
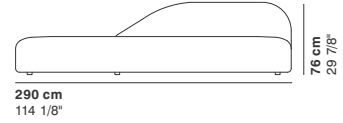

cod. 9025 / **small right peninsula**

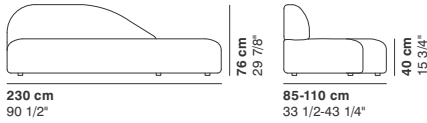

cod. 9026 / **small left peninsula**

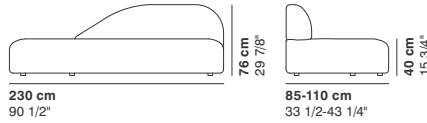

cod. 9006 / **element 100**

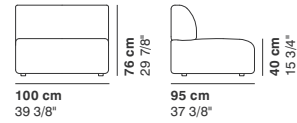

cod. 9007 / **element 150**

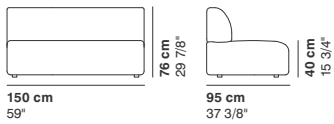

cod. 9008 / **element 200**

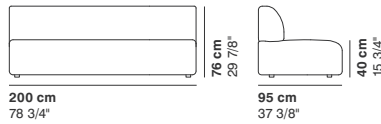

cod. 9009 / **right element 150**

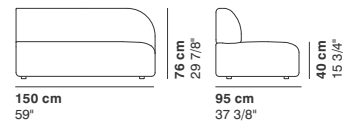

cod. 9010 / **left element 150**

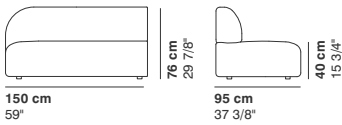

cod. 9011 / **right element 200**

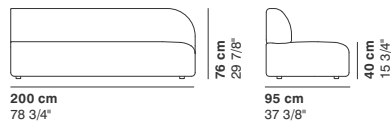

cod. 9012 / **left element 200**

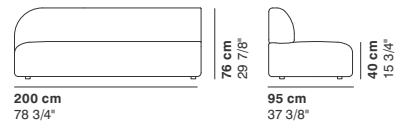

GUEST

cod. 9013 / right element peninsula

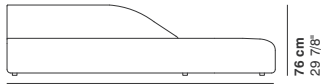

290 cm
114 1/8"
76 cm
29 7/8"

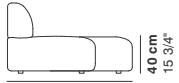

95-135 cm
37 3/8"- 53 1/8"
40 cm
15 3/4"

cod. 9014 / left element peninsula

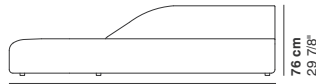

290 cm
114 1/8"
76 cm
29 7/8"

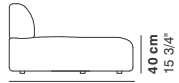

95-135 cm
37 3/8"- 53 1/8"
40 cm
15 3/4"

cod. 9015 / open element curved 100

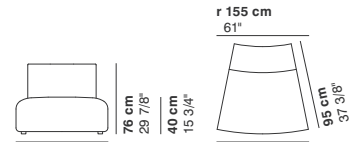

100 cm
39 3/8"
76 cm
29 7/8"
40 cm
15 3/4"
r 155 cm
61"
95 cm
37 3/8"
R 250 cm
98 3/8"

cod. 9016 / closed element curved 100

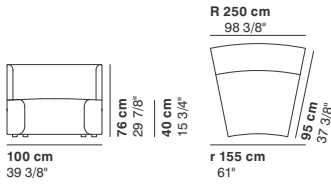

100 cm
39 3/8"
76 cm
29 7/8"
40 cm
15 3/4"
R 250 cm
98 3/8"
r 155 cm
61"
95 cm
37 3/8"

cod. 9017 / open element curved 200

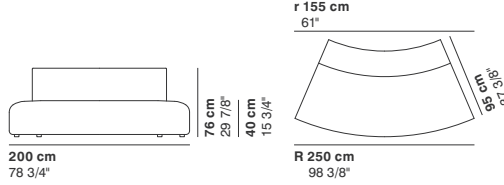

200 cm
78 3/4"
76 cm
29 7/8"
40 cm
15 3/4"
r 155 cm
61"
R 250 cm
98 3/8"
95 cm
37 3/8"

cod. 9018 / closed element curved 200

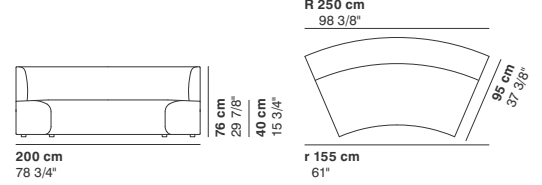

200 cm
78 3/4"
76 cm
29 7/8"
40 cm
15 3/4"
R 250 cm
98 3/8"
r 155 cm
61"
95 cm
37 3/8"

cod. 9019 / ottoman diam.70

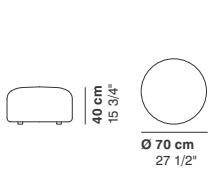

40 cm
15 3/4"
Ø 70 cm
27 1/2"

cod. 9020 / ottoman diam.100

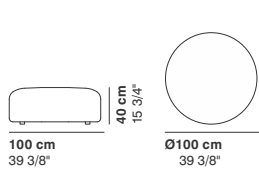

100 cm
39 3/8"
40 cm
15 3/4"
Ø 100 cm
39 3/8"

cod. 9021 / ottoman diam.130

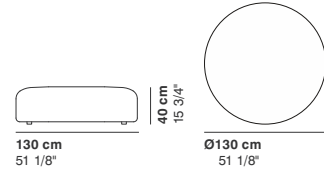

130 cm
51 1/8"
40 cm
15 3/4"
Ø 130 cm
51 1/8"

GUEST

cod. GUE01 / composition

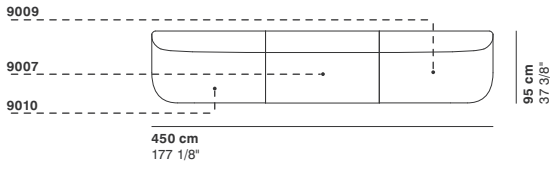

cod. GUE02 / composition

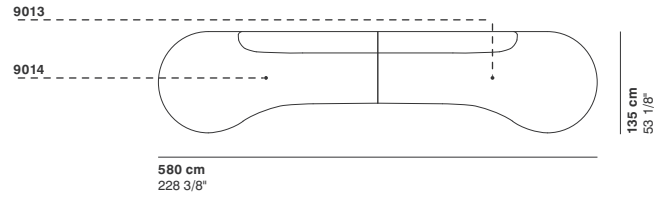

cod. GUE03 / composition

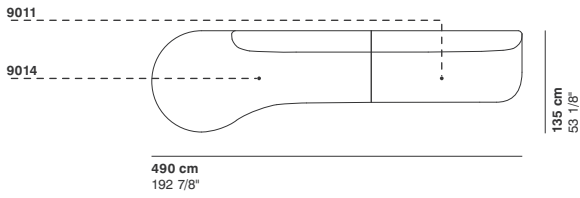

cod. GUE04 / composition

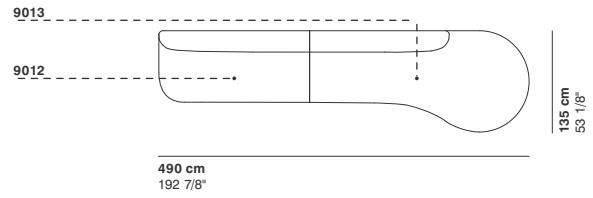

cod. GUE05 / composition

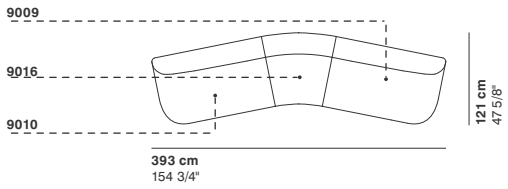

cod. GUE06 / composition

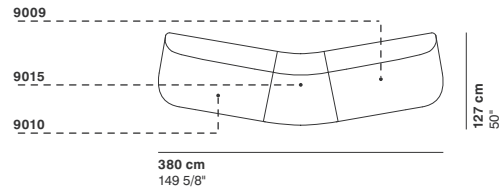

cod. GUE07 / composition

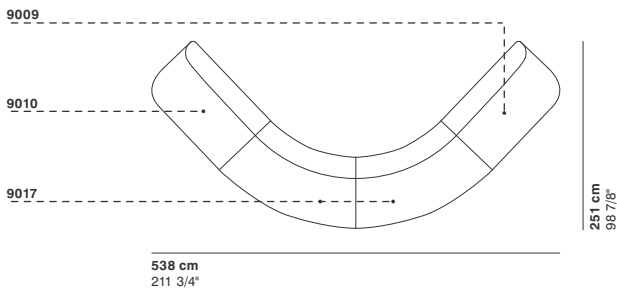

cod. GUE08 / composition

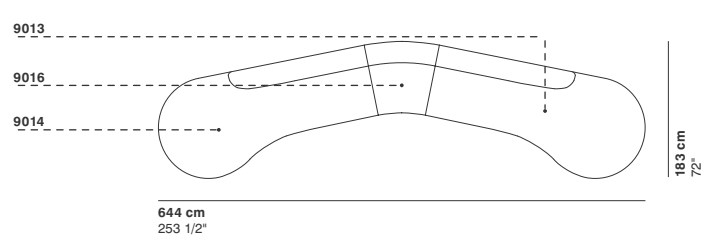

La Cividina s.r.l., al fine di migliorare caratteristiche tecniche e qualitative della sua produzione, si riserva di apportare, anche senza preavviso, tutte le modifiche che si rendessero necessarie.

With a view to improving the technical characteristics and quality of its products, La Cividina s.r.l. reserves the right to develop its products at anytime without notice.

Afin d'améliorer les caractéristiques techniques et qualitatives de sa production, La Cividina s.r.l. se réserve d'apporter, même sans préavis, toutes les modifications qui se rendront nécessaires.

Zur Verbesserung der technischen und qualitativen Merkmale, behält sich La Cividina s.r.l. vor, alle notwendig erscheinenden Produktionsänderungen, auch ohne Vorankündigung durchzuführen.



ISO 9001

LaCividina srl

**HEADQUARTERS
/ PRODUCTION**

Via Cividina 176
33035 Martignacco
Udine Italy

SHOWROOM

Via Lungolavia 1
33035 Martignacco
Udine Italy

T. + 39 0432 677433

F. + 39 0432 677480

info@lacividina.com

www.lacividina.com

VAT nr. IT01810870301