

---

# Elle P

---

**Family**

Armchair / Small armchair / Sofa

---

**Designer**

Luca Botto / 2012

---

**Link**

[www.read-mo.re/elle\\_p](http://www.read-mo.re/elle_p)



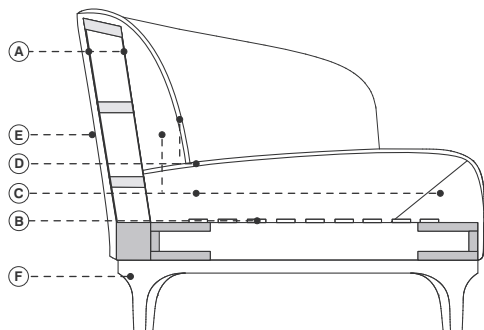

- |  |   |  |  |
|--|---|--|--|
| ■ Legno massiccio di abete   | ■ Solid fir   | ■ Bois de sapin massif   | ■ Massiveholz aus Tanne  |
| ■ Legno massiccio di faggio  | ■ Solid beech   | ■ Bois de hêtre massif   | ■ Massiveholz aus Buche  |
| <b>A.</b> Pannello di masonite   | <b>A.</b> Masonite panels   | <b>A.</b> Panneau de particules  | <b>A.</b> Holzfaserplatte  |
| <b>B.</b> Cinghie elastiche ad alta densità                                | <b>B.</b> High density elastic straps   | <b>B.</b> Sangles élastiques   | <b>B.</b> Elastischen Gurtbändern  |
| <b>C.</b> Poliuretano espanso ignifugo indeformabile a quote differenziate | <b>C.</b> Flame-retardant undeformable polyurethane foam of different densities | <b>C.</b> Mousse polyuréthane expansé ignifuge indéformable à épaisseurs différenciées | <b>C.</b> Feuerfester formbeständige Polyurethanschaum in unterschiedlicher Dichte |
| <b>D.</b> Fibra di poliestere  | <b>D.</b> Polyester fibers  | <b>D.</b> Fibre de polyester   | <b>D.</b> Polyester  |
| <b>E.</b> Rivestimento fisso in tessuto o pelle                            | <b>E.</b> Fixed upholstery in fabric or leather                                 | <b>E.</b> Revêtement pas déhoussable en tissu ou cuir                                  | <b>E.</b> Unabziehbarer Bezug aus Stoff oder Leder                                 |
| <b>F.</b> Legno di faggio  | <b>F.</b> Beech wood  | <b>F.</b> Bois de hêtre  | <b>F.</b> Buchenholz   |

Note · Notes · Annotation · Anmerkung

- |  |   |   |  |
|--|---|---|--|
| <ul style="list-style-type: none"> <li>• Prodotto disponibile su misura con preventivo su richiesta</li> <li>• Cuscini extra disponibili</li> <li>• COM: tessuto cliente (tinta unita e h.140 cm.) - campione richiesto</li> <li>• COL: pelle cliente - campione richiesto</li> <li>• CAT. SPECIAL: prezzo e disponibilità su richiesta</li> </ul> | <ul style="list-style-type: none"> <li>• This item can be tailor made with price on request</li> <li>• Extra cushions available</li> <li>• COM: client's fabric (plain colour and width 140 cm.) - sample required</li> <li>• COL: client's leather - sample required</li> <li>• CAT. SPECIAL: price and availability on request</li> </ul> | <ul style="list-style-type: none"> <li>• Collection personnalisable sur demande</li> <li>• Autres coussins disponibles</li> <li>• COM: tissu fourni (couleur unie et hauteur 140 cm.) - échantillon nécessaire</li> <li>• COL: cuir fourni - échantillon nécessaire</li> <li>• CAT. SPECIAL: prix et disponibilité sur demande</li> </ul> | <ul style="list-style-type: none"> <li>• Produkt nach Maß verfügbar auf Anfrage</li> <li>• Weitere Kissen verfügbar</li> <li>• COM: Kundenstoff (einfarbig und Breite 140 cm.) - Stoffmuster nötig</li> <li>• COL: Kundenleder - Ledermuster nötig</li> <li>• CAT. SPECIAL: Preis und Verfügbarkeit auf Anfrage</li> </ul> |
|--|---|---|--|

Finiture in legno · Wooden finishes · Finitions bois · Holzausführungen



Nero (RAL 9005)  
 Black (RAL 9005)  
 Noir (RAL 9005)  
 Schwarz (RAL 9005)

Rivestimenti consigliati · Recommended coverings · Revêtements conseillées · Empfohlene Bezüge

- |                         |                       |                              |                             |
|-------------------------|-----------------------|------------------------------|-----------------------------|
| • cat. A XTREME         | • cat. C SUPERB       | • cat. extra RIME            | • cat. maxi MOSAIC 2        |
| • cat. A TAILOR         | • cat. C DEANS        | • cat. extra MOLLY 2         | • cat. maxi UNIFORM MÉLANGE |
| • cat. A ANGEL          | • cat. C IRIS         | • cat. extra STEELCUT TRIO 3 | • cat. maxi HALLINGDAL 65   |
| • cat. A SAMAR          | • cat. C TREND        | • cat. extra ARIANA          | • cat. maxi DIVINA 3        |
| • cat. A AVON           | • cat. super AMELIA   | • cat. extra COLLINE         | • cat. top ARDA             |
| • cat. A MAGNUM         | • cat. super NOX      | • cat. extra OPERA           | • cat. special GENTLE 2     |
| • cat. A CRAZY          | • cat. super ORSETTO  | • cat. extra ARCO            | • cat. special SISU         |
| • cat. B WILSON         | • cat. super REMIX 3  | • cat. extra CREDO           | • cat. lux LUX 1            |
| • cat. B FAME           | • cat. super TERASKIN | • cat. extra CLEO            | • cat. lux LUX 2            |
| • cat. B MAIN LINE FLAX | • cat. super FOSTER   | • cat. extra TRIO            | • cat. imperial IMPERIAL 1  |
| • cat. B HERO           |                       | • cat. extra BIT             | • cat. imperial IMPERIAL 2  |
| • cat. B HESTAN         |                       |                              |                             |
| • cat. B SATEN          |                       |                              |                             |
| • cat. B SILVERTEX      |                       |                              |                             |

# ELLE P

cod. 8790 / **small armchair**

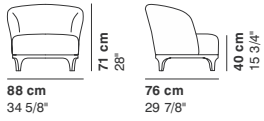

cod. 8750 / **armchair**

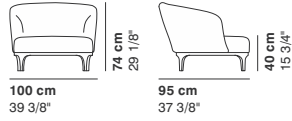

cod. 8751 / **2 seater**

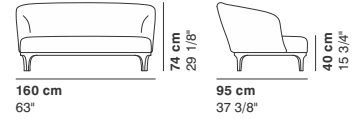

cod. 8752 / **2 seater major**

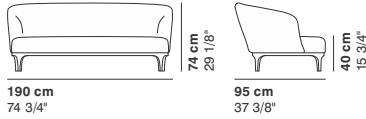

cod. 8753 / **3 seater**



cod. 8791 / **small armchair with cushion**

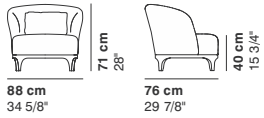

cod. 8755 / **armchair with cushion**

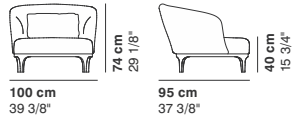

cod. 8756 / **2 seater with cushions**

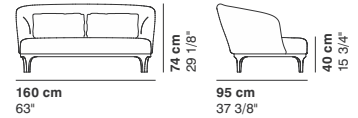

cod. 8757 / **2 seater major with cushions**

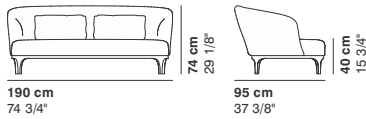

cod. 8758 / **3 seater with cushions**

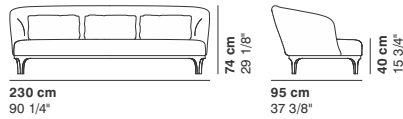

La Cividina s.r.l., al fine di migliorare caratteristiche tecniche e qualitative della sua produzione, si riserva di apportare, anche senza preavviso, tutte le modifiche che si rendessero necessarie.

With a view to improving the technical characteristics and quality of its products, La Cividina s.r.l. reserves the right to develop its products at anytime without notice.

Afin d'améliorer les caractéristiques techniques et qualitatives de sa production, La Cividina s.r.l. se réserve d'apporter, même sans préavis, toutes les modifications qui se rendront nécessaires.

Zur Verbesserung der technischen und qualitativen Merkmale, behält sich La Cividina s.r.l. vor, alle notwendig erscheinenden Produktionsänderungen, auch ohne Vorankündigung durchzuführen.



ISO 9001

**LaCividina srl**

**HEADQUARTERS  
/ PRODUCTION**

Via Cividina 176  
33035 Martignacco  
Udine Italy

**SHOWROOM**

Via Lungolavia 1  
33035 Martignacco  
Udine Italy

T. + 39 0432 677433

F. + 39 0432 677480

info@lacividina.com

www.lacividina.com

VAT nr. IT01810870301