

---

# Bernard

---

**Family**

Armchair / Small armchair / Sofa /  
Dormeuse / Ottoman / Bench /  
System / Coffee table

---

**Designer**

Nina Mair / 2020

---

**Link**

[www.read-mo.re/bernard](http://www.read-mo.re/bernard)



Armchair

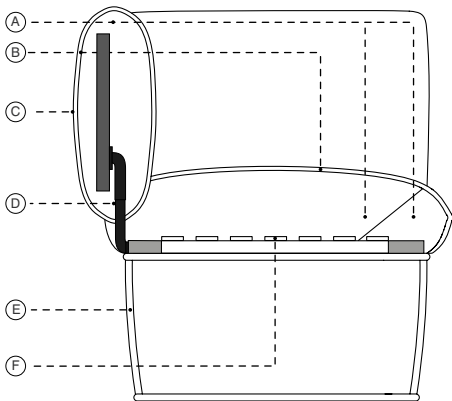

Coffee table

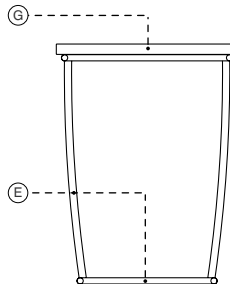

- Legno massiccio di faggio
- Multistrato di faggio
- A. Poliuretano espanso ignifugo a quote differenziate
- B. Fibra di poliestere
- C. Rivestimento fisso in tessuto o pelle
- D. Acciaio
- E. Acciaio verniciato
- F. Cinghie elastiche ad alta densità
- G. MDF / Rovere spazzolato / Marmo

- Solid beech
- Multilayered beech
- A. Flame-retardant undeformable polyurethane foam of different densities
- B. Polyester fibers
- C. Fixed upholstery in fabric or leather
- D. Steel
- E. Lacquered steel
- F. High density elastic straps
- G. MDF / Brushed oak / Marble

- Bois de hêtre massif
- Multiplis de hêtre
- A. Mousse polyuréthane expansé ignifuge indéformable à épaisseurs différenciées
- B. Fibre de polyester
- C. Revêtement pas déhoussable en tissu ou cuir
- D. Acier
- E. Acier laqué
- F. Sangles élastiques
- G. MDF / Chêne brossé / Marbre

- Massivholz aus Buche
- Buchenschichtholz
- A. Feuerfesterformbeständige Polyurethanschäum in unterschiedlicher Dichte
- B. Polyester
- C. Unabziehbarer Bezug aus Stoff oder Leder
- D. Stahl
- E. Lackierter Stahl
- F. Elastischen Gurtbändern
- G. MDF/Eichenholzgebürstet/Marmor

Note · Notes · Annotation · Anmerkung

- Cuscini extra disponibili
- COM: tessuto cliente (tinta unita e h.140 cm.) - campione richiesto
- COL: pelle cliente - campione richiesto
- CAT. SPECIAL: prezzo e disponibilità su richiesta
- Extra cushions available
- COM: client's fabric (plain colour and width 140 cm.) - sample required
- COL: client's leather - sample required
- CAT. SPECIAL: price and availability upon request
- Autres coussins disponibles
- COM: tissu fourni (couleur unie et hauteur 140 cm.) - échantillon nécessaire
- COL: cuir fourni - échantillon nécessaire
- CAT. SPECIAL: prix et disponibilité sur demande
- Weitere Kissen verfügbar
- COM: Kundenstoff (einfarbig und Breite 140 cm.) - Stoffmuster nötig
- COL: Kundenleder - Ledermuster nötig
- CAT. SPECIAL: Preis und Verfügbarkeit auf Anfrage

Finitura base · Base finish · Finition de piètement · Gestell Ausführung



Avorio  
Ivory  
Ivoire  
Elfenbein



Fango  
Mud  
Boue  
Schlamm



Prugna  
Plum  
Prune  
Pflaume



Nero pece  
Pitch black  
Poix noir  
Pech Schwarz

Rivestimenti consigliati · Recommended coverings · Revêtements conseillées · Empfohlene Bezüge

- |          |                |              |               |              |                 |                 |            |
|----------|----------------|--------------|---------------|--------------|-----------------|-----------------|------------|
| • cat. A | XTREME         | • cat. C     | TREND         | • cat. extra | STEELCUT TRIO 3 | • cat. lux      | LUX 1      |
| • cat. A | STEP           | • cat. C     | SUPERB        | • cat. extra | ARIANA          | • cat. lux      | LUX 2      |
| • cat. A | ANGEL          | • cat. C     | UMAMI         | • cat. extra | COLLINE         | • cat. imperial | IMPERIAL 1 |
| • cat. A | MEDLEY         | • cat. C     | HESTAN        | • cat. extra | OPERA           | • cat. imperial | IMPERIAL 2 |
| • cat. A | MOOD           | • cat. C     | DEANS         | • cat. extra | DANTE           | • cat. imperial | NABUK      |
| • cat. A | CRAZY          | • cat. super | REMIX 2       | • cat. extra | ARCO            | • cat. special  | DROP       |
| • cat. B | EXTREMA        | • cat. super | CAPTURE       | • cat. maxi  | UNIFORM MÉLANGE |                 |            |
| • cat. B | IKON           | • cat. super | MODA          | • cat. maxi  | HALLINGDAL 65   |                 |            |
| • cat. B | SILVERTEX      | • cat. super | REVIVE 1      | • cat. maxi  | COMFORT         |                 |            |
| • cat. B | SAMAR          | • cat. super | BREEZE FUSION | • cat. maxi  | DIVINA 3        |                 |            |
| • cat. B | FAME           | • cat. extra | MOLLY         |              |                 |                 |            |
| • cat. B | MAIN LINE FLAX | • cat. extra | RIME          |              |                 |                 |            |

Finiture piano tavolo · Table top finishes · Finitions de plateau de table · Tischplatten Ausführungen



Rovere spazzolato naturale  
Natural brushed oak  
Chêne brossé naturel  
Eichenholz Natural gebürstet



Rovere spazzolato grafite  
Graphite brushed oak  
Chêne brossé graphite  
Eichenholz Graphit gebürstet



Rovere spazzolato bianco  
White brushed oak  
Chêne brossé blanc  
Eichenholz Weiß gebürstet



MDF bianco (RAL 9016)  
MDF white (RAL 9016)  
MDF blanc (RAL 9016)  
MDF Weiß (RAL 9016)



MDF nero (RAL 9005)  
MDF black (RAL 9005)  
MDF noir (RAL 9005)  
MDF Schwarz (RAL 9005)



Marmo Marquina  
Marquina marble  
Marbre Marquina  
Marquina Marmor



Marmo Carrara  
Carrara marble  
Marbre Carrara  
Carrara Marmor



Marmo Calacatta  
Calacatta marble  
Marbre Calacatta  
Calacatta Marmor

cod. 1120 / **armchair corner small**

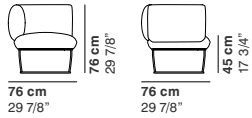

cod. 1121 / **armchair central small**

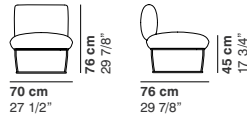

cod. 1122 / **armchair small**

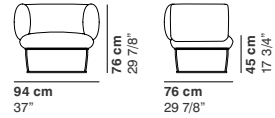

cod. 1124 / **small ottoman**

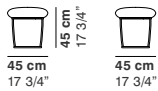

cod. 1125 / **medium ottoman**

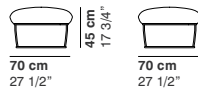

# BERNARD

cod. 1130 / **armchair**

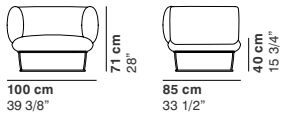

cod. 1131 / **armchair central**

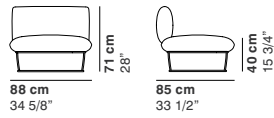

cod. 1132 / **2 seater sofa**

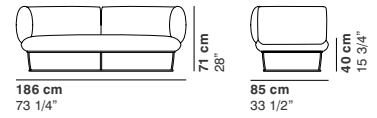

cod. 1133 / **3 seater sofa**

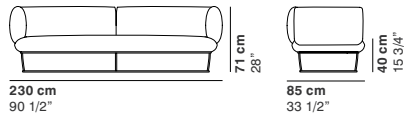

cod. 1134 / **dormeuse**

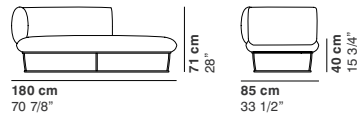

cod. 1135 / **large ottoman**

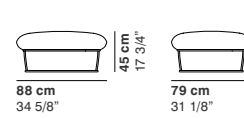

cod. 1136 / **bench**

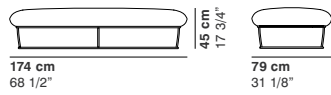

cod. 1140 / **coffee table small**



cod. 1141 / **coffee table medium**

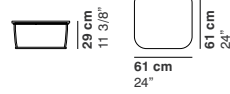

La Cividina s.r.l., al fine di migliorare caratteristiche tecniche e qualitative della sua produzione, si riserva di apportare, anche senza preavviso, tutte le modifiche che si rendessero necessarie.

With a view to improving the technical characteristics and quality of its products, La Cividina s.r.l. reserves the right to develop its products at anytime without notice.

Afin d'améliorer les caractéristiques techniques et qualitatives de sa production, La Cividina s.r.l. se réserve d'apporter, même sans préavis, toutes les modifications qui se rendront nécessaires.

Zur Verbesserung der technischen und qualitativen Merkmale, behält sich La Cividina s.r.l. vor, alle notwendig erscheinenden Produktionsänderungen, auch ohne Vorankündigung durchzuführen.



ISO 9001



ACCREDIA



FSC



CATAS



MADE IN ITALY

**LaCividina srl**

**HEADQUARTERS  
/ PRODUCTION**

Via Cividina 176  
33035 Martignacco  
Udine Italy

**SHOWROOM**

Via Lungolavia 1  
33035 Martignacco  
Udine Italy

T. + 39 0432 677433

F. + 39 0432 677480

info@lacividina.com

www.lacividina.com

VAT nr. IT01810870301