Manhattan

Family

Armchair / Sofa / Dormeuse /
Ottoman / System

Designer

Fulvio Bulfoni / 1996

Link

www.read-mo.re/manhattan



MANHATTAN

Dati tecnici · Technical data · Données techniques · Technische Angaben

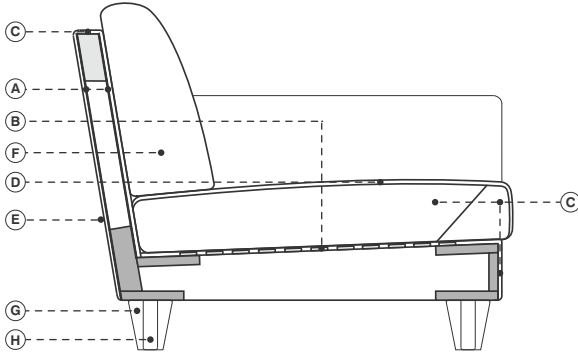

- Legno massiccio di abete
- Legno massiccio di faggio
- A. Pannello di masonite
- B. Cinghie elastiche ad alta densità
- C. Poliuretano espanso ignifugo indeformabile a quote differenziate
- D. Fibra di poliestere
- E. Rivestimento sfoderabile in tessuto e non sfoderabile in pelle e finta pelle
- F. Piuma e fibra di poliestere elicoidale
- G. Legno di faggio
- H. Alluminio

- Solid fir
- Solid beech
- A. Masonite panels
- B. High density elastic straps
- C. Flame-retardant undeformable polyurethane foam of different densities
- D. Polyester fibers
- E. Removable upholstery in fabric and fixed in leather or artificial leather
- F. Feathers and helical polyester fibers
- G. Beech wood
- H. Aluminium

- Bois de sapin massif
- Bois de hêtre massif
- A. Panneau de particules
- B. Sangles élastiques
- C. Mousse polyuréthane expansé ignifuge indéformable à épaisseurs différenciées
- D. Fibre de polyester
- E. Revêtement déhoussable en tissu et pas déhoussable en cuir ou simili cuir
- F. Plume et fibre de polyester hélicoïdale
- G. Bois de hêtre
- H. Aluminium

- Massivholz aus Tanne
- Massivholz aus Buche
- A. Holzfaserplatte
- B. Elastischer Gurtbändern
- C. Feuerfester formbeständige Polyurethanschaum in unterschiedlicher Dichte
- D. Polyester
- E. Abziehbarer Bezug aus Stoff oder unabziehbarer aus Leder und Kunstleder
- F. Daunen und Polyesterfaser spiralförmig
- G. Buchenholz
- H. Aluminium

Note · Notes · Annotation · Anmerkung

- Piedi personalizzabili con tinta cliente
- Prodotto disponibile su misura con preventivo su richiesta
- Su richiesta attacco per connessione elettrica e USB con sovrapprezzo
- Cuscini extra disponibili
- COM: tessuto cliente (tinta unita e h.140 cm.) - campione richiesto
- COL: pelle cliente - campione richiesto
- CAT. SPECIAL: prezzo e disponibilità su richiesta

- Feet customizable with customer's colors on request
- This item can be tailor made with price on request
- Electrical connection and USB upon request with upcharge
- Extra cushions available
- COM: client's fabric (plain colour and width 140 cm.) - sample required
- COL: client's leather - sample required
- CAT. SPECIAL: price and availability on request

- Pieds personnalisable avec coloris du sur demande
- Collection personnalisable sur demande
- Sur demande connection électrique et USB avec surcoût
- Autres coussins disponibles
- COM: tissu fourni (couleur unie et hauteur 140 cm.) - échantillon nécessaire
- COL: cuir fourni - échantillon nécessaire
- CAT. SPECIAL: prix et disponibilité sur demande

- Füße in Kundenfarben auf Anfrage verfügbar
- Produkt nach Maß verfügbar auf Anfrage
- Elektrische Verbindung und USB-Anschluss auf Anfrage gegen Aufpreis
- Weitere Kissen verfügbar
- COM: Kundenstoff (einfarbig und Breite 140 cm.) - Stoffmuster nötig
- COL: Kundenleder - Ledermuster nötig
- CAT. SPECIAL: Preis und Verfügbarkeit auf Anfrage

Finiture in legno · Wooden finishes · Finitions bois · Holzausführungen



Faggio naturale
Natural beech
Hêtre naturel
Buchenholz Naturfarbe



Faggio tinto noce
Walnut-stained beech
Hêtre teinté noyer
Buchenholz Nussbaum gebeizt



Alluminio lucido
Polished aluminum
Aluminium brillant
Poliert Aluminium



Alluminio opaco
Matt aluminum
Aluminium mat
Aluminium matt

Opzione · Option · Option · Opzion



Su richiesta attacco per connessione elettrica e USB con sovrapprezzo
Electrical connection and USB upon request with upcharge
Sur demande connection électrique et USB avec surcoût
Elektrische Verbindung und USB-Anschluss auf Anfrage gegen Aufpreis

Sistema di aggancio · System connector · Systeme d'assemblage · Verbindungshaken



Sistema di aggancio tra elementi
Components connector
Systeme d'assemblage de socle
Verbindungssystem zwischen Elemente

Rivestimenti consigliati · Recommended coverings · Revêtements conseillées · Empfohlene Bezüge

- cat. A XTREME
- cat. A STEP
- cat. A ANGEL
- cat. A MEDLEY
- cat. A MOOD
- cat. A CRAZY
- cat. B EXTREMA
- cat. B IKON
- cat. B SILVERTEX
- cat. B SAMAR
- cat. B FAME
- cat. B MAIN LINE FLAX

- cat. C TREND
- cat. C SUPERB
- cat. C UMAMI
- cat. C HESTAN
- cat. C DEANS
- cat. super REMIX 2
- cat. super CAPTURE
- cat. super MODA
- cat. super REVIVE 1
- cat. super BREEZE FUSION

- cat. extra MOLLY
- cat. extra RIME
- cat. extra STEELCUT TRIO 3
- cat. extra ARIANA
- cat. extra COLLINE
- cat. extra OPERA
- cat. extra DANTE
- cat. extra ARCO
- cat. maxi HALLINGDAL 65
- cat. maxi COMFORT
- cat. maxi DIVINA 3

- cat. lux LUX 1
- cat. lux LUX 2
- cat. imperial IMPERIAL 1
- cat. imperial IMPERIAL 2
- cat. imperial NABUK
- cat. special DROP

MANHATTAN

cod. 5100 / **armchair**

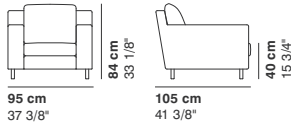

cod. 5102 / **2 seater**

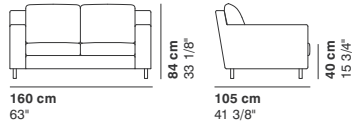

cod. 5103 / **2 seater major**

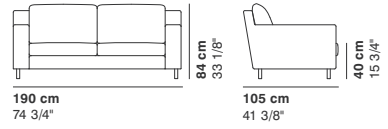

cod. 5104 / **3 seater**

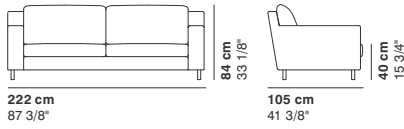

cod. 5105 / **3 seater major**

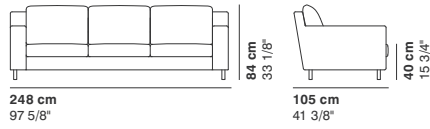

cod. 5106 / **corner**

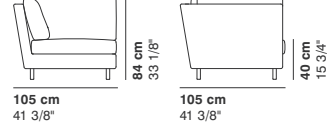

cod. 5107 / **element 70**

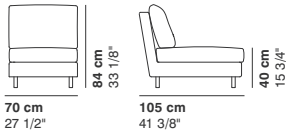

cod. 5108 / **right element 86**

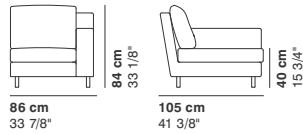

cod. 5109 / **left element 86**

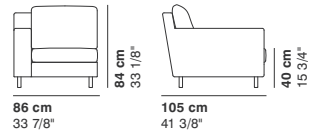

cod. 5110 / **right element 144**

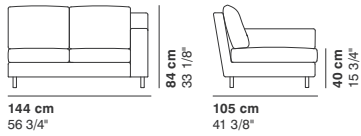

cod. 5111 / **left element 144**

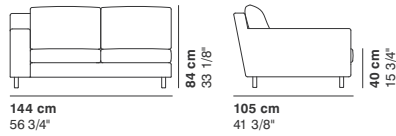

cod. 5112 / **right element 206**

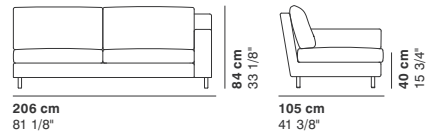

cod. 5113 / **left element 206**

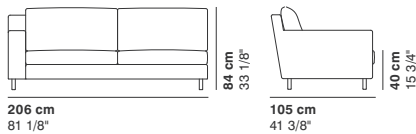

cod. 5114 / **right small dormeuse**

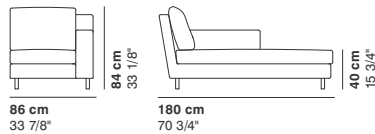

cod. 5115 / **left small dormeuse**

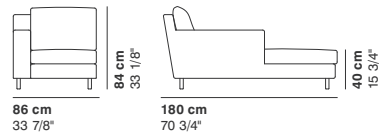

cod. 5116 / **right big dormeuse**

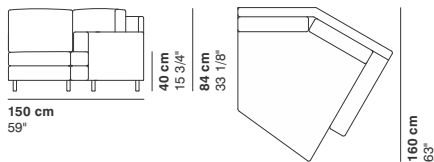

cod. 5117 / **left big dormeuse**

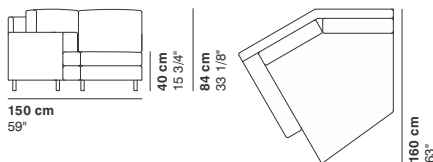

cod. 5118 / **ottoman 60**



cod. 5119 / **ottoman 100**



La Cividina s.r.l., al fine di migliorare caratteristiche tecniche e qualitative della sua produzione, si riserva di apportare, anche senza preavviso, tutte le modifiche che si rendessero necessarie.

With a view to improving the technical characteristics and quality of its products. La Cividina s.r.l. reserves the right to develop its products at anytime without notice.

Afin d'améliorer les caractéristiques techniques et qualitatives de sa production, La Cividina s.r.l. se réserve d'apporter, même sans préavis, toutes les modifications qui se rendront nécessaires.

Zur Verbesserung der technischen und qualitativen Merkmale, behält sich La Cividina s.r.l. vor, alle notwendig erscheinenden Produktionsänderungen, auch ohne Vorankündigung durchzuführen.



ISO 9001



ACCREDIA



FSC



CATAS



MADE IN ITALY

LaCividina srl

**HEADQUARTERS
/ PRODUCTION**

Via Cividina 176
33035 Martignacco
Udine Italy

SHOWROOM

Via Lungolavia 1
33035 Martignacco
Udine Italy

T. + 39 0432 677433

F. + 39 0432 677480

info@lacidina.com

www.lacidina.com

VAT nr. IT01810870301